



tools

2026

HOJA DE PEDIDOS / FICHE DE COMMANDES

—	Hoja para pedidos de herramientas especiales	VI
—	Fiche de commandes d'outils spéciaux	VII

BROCAS / MÈCHES

■	Brocas ciegas y pasantes MD integral / Mèches borgnes et débouchants HM monobloc	1
■	Brocas ciegas punta MD / Mèches borgnes pointe HM	2
■	Brocas pasantes punta MD / Mèches débouchants pointe HM	3
■	Portabrocas M10 - Guía T1 / Porte-mèches M10 - Guide T1	3
■	Brocas MD integral + Adaptadores / Mèches HM monobloc + Adaptateurs	4
■	Brocas para herrajes PCD / Mèches à façonner PCD	4
■	Brocas para herrajes MD / Mèches à façonner HM	5

HERRAMIENTAS DE MANGO / OUTILS À QUEUE

■	Fresas MD integral para: / Fraises HM monobloc pour: GRAFITO, GFK, CFK, HPL, TEXTOLITE	6
■	Fresas MD integral Z1 para PLEXI, PVC (plásticos) - Fraises HM monobloc Z1 pour PLEXI, PVC (plastiques)	8
■	Fresas MD integral Z1 para ALUMINIO / Fraises HM monobloc Z1 pour ALUMINIUM	8
■	Fresas MD integral Hél. pos./neg. / Fraises HM monobloc Hél. pos./neg.	9
■	Fresas MD integral helicoidales (acabado) / Fraises HM monobloc helicoidales (finition)	10
■	Fresas MD integral helicoidales (desbaste) / Fraises HM monobloc helicoidales (ébauche)	12
■	Fresas MD integral para cajeados de cerraduras / Outils monobloc pour logement de serrures	12
■	Fresas / Fraises Peanut, Lamello, Alucobond	13
■	Fresas de PCD rectas / Fraises de PCD droites	14
■	Fresas de PCD rectas multicorte / Fraises de PCD droites multi-coupe	15
■	Nesting	16
■	Herramientas para planear / Outils à surfacer	17
■	Cabezales para taladrar y contornear / Porte-outils à défonceur	18
■	Cabezales para canteado, galces y cerraduras / Porte-outils à dresser et serrures	19
■	Fresas angulares PCD / Cabezal Multiperfil / Fraises angulaires PCD / P.O. Multi-profil	20
■	Cabezales angulares para biselado/folding / Porte-outils angulaires pour chanfreiner/folding	21
■	Herramientas para uñeros / Outils pour poignées de porte	22

HERRAMIENTAS DE EJE / OUTILS À ALÉSAGE

■	Fresas rectas / Fraises droites	24
■	Cabezales rectos / Porte-outils droits	25
■	Fresas MD extensibles / Fraises HM extensibles	26
■	Fresas angulares / Fraises angulaires	27
■	Fresas/cabezales para juntas / Fraises/Porte-outils pour joints	28
■	Fresas microensambles / Fraises pour joints collés empilables	29
■	Fresas/cabezales para juntas encoladas / Fraises/Porte-outils pour joints collés	30
■	Cabezales machihembrado / Porte-outils à rainure-languette	32
■	Fresas/cabezales para uñeros / Outils pour poignées de porte	34
■	Fresas para plafones / Fraises plate bande	36
■	Fresas de radios / Fraises rayon	38
■	Fresa Lamello / Mandrino mango Ø20 / Fraise Lamello / Mandrin queue Ø20	39
■	Cabezal multiperfil (68CB, cuchillas corrugadas) / Porte-outils multiprofil (68CB, fers crantés)	40
■	Cabezal multiperfil 67CB / Porte-outils multiprofil 67CB	41
■	Cuchillas estándar 67CB / Plaquettes standard 67CB	42
■	Fresas para puertas / Fraises pour portes	46
■	Cabezales para puertas / Porte-outils pour portes	48

RETESTADO ALUMINIO / USINAGE ALUMINIUM

■	Fresas rectas para retestado / Fraises droites pour aluminium	50
■	Anillas de separación / Bagues de séparation	51
■	Casquillos portafresas / Arbres porte-outils	51

CUCHILLAS / PLAQUETTES

Cuchillas MD reversibles / <i>Plaquettes HM réversibles</i>	52
Precortadores / <i>Araseurs</i>	52
Cuchillas para cabezal cerraduras / <i>Plaquettes pour p.o. logement de serrures</i>	53
Cuchillas para cepillar (12CR) / <i>Fers de rabotage (12CR)</i>	53
Cuchillas corrugadas perfiladas (17CR) / <i>Fers crantés profilés (17CR)</i>	40
Cuchillas para cepillos electroportátiles / <i>Plaquettes réversibles pour rabot électroportatif</i>	54
Cuchillas tipo CENTROLOCK / <i>Fers de rabotage CENTROLOCK</i>	54
Cuchillas tipo TERSA / <i>Fers de rabotage TERSA</i>	55
Ranuradores, chaflanadores y redondeadores / <i>Plaquettes à rainer, chanfreiner et arrondir</i>	56
Gubias HSS / <i>Gouge HSS pour tournage</i>	56

ACCESORIOS / ACCESSOIRES

Portapinzas/porta-herramientas / <i>Mandrin/arbre porte-outils</i>	57
Pinzas / <i>Pinces</i>	58
Mandrinos portasierras / <i>Mandrin porte-lames</i>	58
Juego 2 anillos para reducción de eje / <i>Jeu de 2 bagues de réduction</i>	59
Anillas de separación / <i>Bagues de séparation</i>	59
Anillas de reducción de eje para discos / <i>Bagues de réduction pour lames circulaires</i>	60
Cojinete tope / <i>Roulement + bague de guidage</i>	60
Tornillería / <i>Vis, écrous et clés</i>	61

DISCOS / LAMES CIRCULAIRES

Discos para ranurar / <i>Lames circulaires à rainer</i>	64
Discos alternos con limitador / <i>Lames circulaires à délimiter, avec limiteurs</i>	64
Discos alternos para maderas gruesas / <i>Lames circulaires alternées, à délimiter</i>	64
Discos alternos para múltiple / <i>Lames circulaires alternées, pour multiple</i>	65
Discos alternos, universal / <i>Lames circulaires alternées, universelles</i>	65
Discos alternos para tableros / <i>Lames circulaires alternées, pour panneaux</i>	65
Discos Tr-PI para paneles recubiertos / <i>Lames circulaires Tr-PI, pour panneaux revêtus</i>	65
Discos Tr-PI para paneles recubiertos, MD y PCD / <i>Lames circ. Tr-PI, pour panneaux revêtus, HM et PCD</i>	66
Discos Tr-PI para seccionadora / <i>Lames circulaires Tr-PI, pour scie à panneaux</i>	67
Discos incisores cónicos/extensibles / <i>Incisateurs coniques/extensibles</i>	67
Discos Tr-PI para aluminio / <i>Lames circulaires Tr-PI, pour aluminium</i>	68
Discos/Segmentos para trituradores / <i>Lames circulaires/Segments pour déchiqueteur</i>	68
Trituradores / <i>Déchiqueteurs</i>	68

HTAS. FABRICACION ESPECIAL / OUTILS FABRICATION SPÉCIALE

Brocas escalonadas/cabezales "Alambor" / <i>Mèches étagées/porte-outil contour de porte</i>	71
Herramientas de moldura de mango / <i>Outils à profiler à queue</i>	72
Fresas rectas MD / <i>Fraises droites HM</i>	73
Cabezales rectos / <i>Porte-outils droits</i>	74
Cabezal extensible / Fresas PCD canteadora / <i>P.O. Extensible / Fraises PCD plaqueuse de chant</i>	75
Fresas rectas PCD / <i>Fraises droites PCD</i>	76
Fresas y cabezales espigado / <i>Fraises et porte-outils à tenonner</i>	77
Cabezales para cepillar / Cabezal galce de guía / <i>Porte-outils à raboter / prédégauchissage</i>	78
Fresas/cabezales angulares / <i>Fraises/porte outils angulaires</i>	80
Fresas de juntas / <i>Fraises pour joints</i>	81
Fresas machihembrado perfiles rectos / <i>Fraises à rainure-languettes profil droit</i>	82
Fresas machihembrado perfiles decorativos / <i>Fraises à rainure-languettes profil décoratif</i>	83
Fresas de moldura / Palos redondos / <i>Fraises à profiler / bâtons ronds</i>	84
Fresas PCD/cabezales de moldura / <i>Fraises PCD/porte-outils à profiler</i>	85
Cabezales "Alucobond" / <i>Porte-outils "Alucobond"</i>	85
Fresas/cabezales de contramoldura / <i>Fraises/porte-outils contre profil</i>	86
Cuchillas de moldura / <i>Plaquettes à profiler</i>	87
Cuchillas de peladora/descortezadora / <i>Plaquettes pour écorceuses</i>	87
Manguitos portaherramientas / <i>Manchons</i>	87
Bedanos / <i>Bédanes</i>	88

Presupuesto

Pedido

Cliente :

Referencia :

Fecha : / /

Htas. de Eje

Diámetro de Corte (D):

Longitud de Corte (LC):

Diámetro de Eje (d):

Nº. De Cortes (Z):

MD

HSS

PCD

Htas. de Mango

Diámetro de Corte (D):

Longitud de Corte (LC):

Diámetro de Mango (d):

Nº. De Cortes (Z):

Sx.

Dx.



Taladra
Contornea
Taladra y contornea

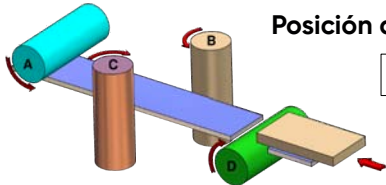

Posición de trabajo:

Material a mecanizar:

Tipo de trabajo / máquina:

Condiciones de trabajo:

R.P.M:

Avance:



Client : _____

Référence : _____

Date : / /

Outils à alésage

Diamètre de coupe (D): _____

Largeur de coupe (LC): _____

Alésage (d): _____

N°. de coupes (Z): _____

HM

HSS

PCD

Outils à queue

Diamètre de coupe (D): _____

Longueur de coupe (LC): _____

Diamètre de queue (S): _____

N°. de coupes (Z): _____

Gauche

Droite



Perçage
Fraisage
Perçage et Fraisage

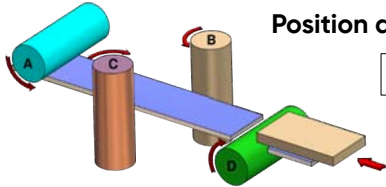

Position de travail:

Materiaux à travailler:	Type de travail / machine:	Conditions de travail:
		R.P.M:
		Avance:

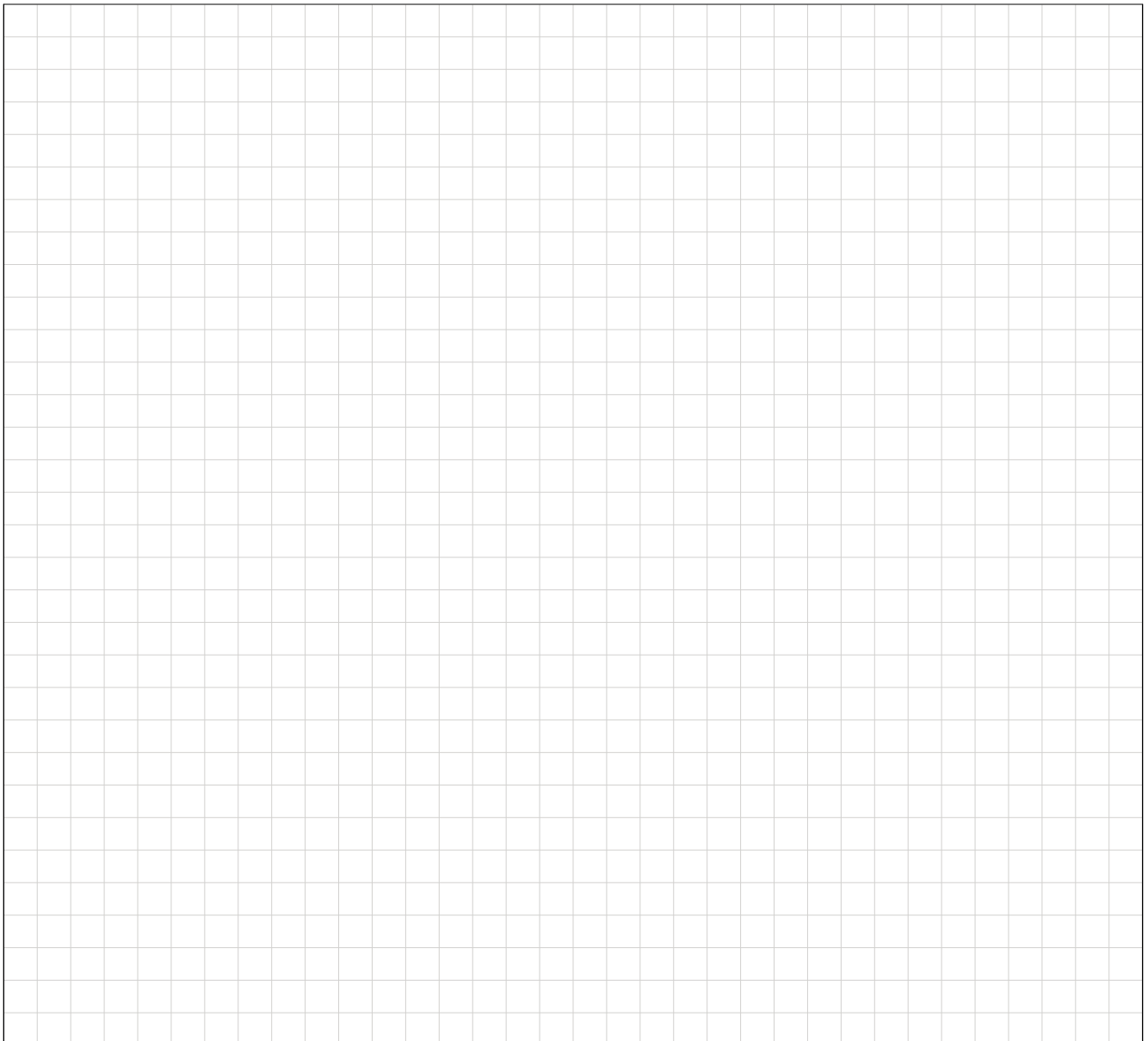

06BH

Broca corta ciega **MD Integral**
Mèche courte borgne **HM Monobloc**

	D	LT	LC	S	Rot.
B0603D	3	57	18	10	Dx.
B0603I	3	57	18	10	Sx.
B0604D	4	57	22	10	Dx.
B0604I	4	57	22	10	Sx.
B0605D	5	57	22	10	Dx.
B0605I	5	57	22	10	Sx.
B0606D	6	57	22	10	Dx.
B0606I	6	57	22	10	Sx.
B0608D	8	57	22	10	Dx.
B0608I	8	57	22	10	Sx.

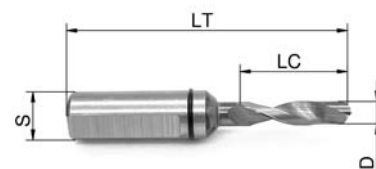

07BH

Broca larga ciega **MD Integral**
Mèche longue borgne **HM Monobloc**

	D	LT	LC	S	Rot.
B0703D	3	70	35	10	Dx.
B0703I	3	70	35	10	Sx.
B0704D	4	70	35	10	Dx.
B0704I	4	70	35	10	Sx.
B0705D	5	70	35	10	Dx.
B0705I	5	70	35	10	Sx.
B0706D	6	70	35	10	Dx.
B0706I	6	70	35	10	Dx.
B0708D	8	70	35	10	Dx.
B0708I	8	70	35	10	Sx.

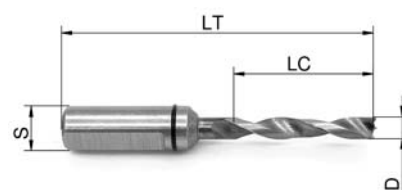

09BH

Broca larga pasante **MD Integral**
Mèche longue débouchante **HM Monobloc**

	D	LT	LC	S	Rot.
B0903D	3	70	27	10	Dx.
B0903I	3	70	27	10	Sx.
B0904D	4	70	35	10	Dx.
B0904I	4	70	35	10	Sx.
B0905D	5	70	35	10	Dx.
B0905I	5	70	35	10	Sx.
B0906D	6	70	35	10	Dx.
B0906I	6	70	35	10	Sx.
B0908D	8	70	35	10	Dx.
B0908I	8	70	35	10	Sx.

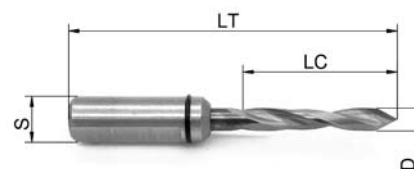

12BH

Broca corta ciega **Punta MD**
Mèche courte borgne **Pointe HM**

	D	LT	LC	S	Rot.
B1204D	4	57	27	10	Dx.
B1204I	4	57	27	10	Sx.
B1205D	5	57	27	10	Dx.
B1205I	5	57	27	10	Sx.
B1206D	6	57	27	10	Dx.
B1206I	6	57	27	10	Sx.
B1208D	8	57	27	10	Dx.
B1208I	8	57	27	10	Sx.
B1210D	10	57	27	10	Dx.
B1210I	10	57	27	10	Sx.
B1212D	12	57	27	10	Dx.
B1212I	12	57	27	10	Sx.
B1214D	14	57	27	10	Dx.
B1214I	14	57	27	10	Sx.
B1215D	15	57	27	10	Dx.
B1215I	15	57	27	10	Sx.

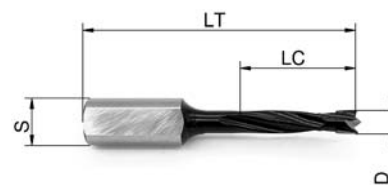

13BH

Broca larga ciega **Punta MD**
Mèche longue borgne **Pointe HM**

	D	LT	LC	S	Rot.
B1304D	4	70	35	10	Dx.
B1304I	4	70	35	10	Sx.
B1305D	5	70	35	10	Dx.
B1305I	5	70	35	10	Sx.
B1306D	6	70	35	10	Dx.
B1306I	6	70	35	10	Sx.
B1307D	7	70	35	10	Dx.
B1307I	7	70	35	10	Sx.
B1308D	8	70	35	10	Dx.
B1308I	8	70	35	10	Sx.
B1310D	10	70	35	10	Dx.
B1310I	10	70	35	10	Sx.
B1312D	12	70	35	10	Dx.
B1312I	12	70	35	10	Sx.
B1315D	15	70	35	10	Dx.
B1315I	15	70	35	10	Sx.

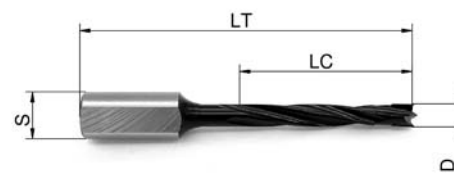

16BH

Broca corta pasante **Punta MD**
 Mèche courte débouchante **Pointe HM**

	D	LT	LC	S	Rot.
B1605D	5	58	27	10	Dx.
B1605I	5	58	27	10	Sx.
B1606D	6	58	27	10	Dx.
B1606I	6	58	27	10	Sx.
B1608D	8	58	27	10	Dx.
B1608I	8	58	27	10	Sx.

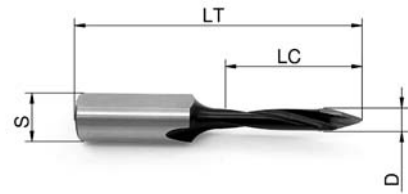

17BH

Broca larga pasante **Punta MD**
 Mèche longue débouchante **Pointe HM**

	D	LT	LC	S	Rot.
B1705D	5	70	35	10	Dx.
B1705I	5	70	35	10	Sx.
B1706D	6	70	35	10	Dx.
B1706I	6	70	35	10	Sx.
B1707D	7	70	35	10	Dx.
B1707I	7	70	35	10	Sx.
B1708D	8	70	35	10	Dx.
B1708I	8	70	35	10	Sx.
B1710D	10	70	35	10	Dx.
B1710I	10	70	35	10	Sx.

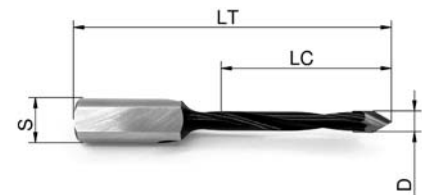

04PB

Portabrocas M10 - Guía D11
 Porte-mèches M10 - Guide D11

	d	LT	Rot.
P2010D	10	40	Dx.
P2010I	10	40	Sx.



20BH

Broca **MD Integral**
 Mèche **HM Monobloc**

	D	LT	LC	S	Rot.
B2002D	2	50	25	2	Dx.
B2002I	2	50	25	2	Sx.
B2025D	2.5	55	27	2.5	Dx.
B2025I	2.5	55	27	2.5	Sx.
B2003D	3	55	27	3	Dx.
B2003I	3	55	27	3	Sx.
B2035D	3.5	55	27	3.5	Dx.
B2035I	3.5	55	27	3.5	Sx.

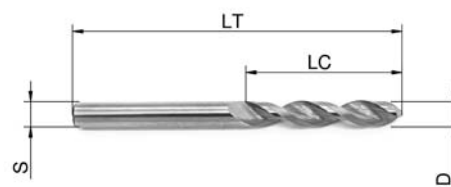

21BH

Adaptador para broca 20BH
 Adaptateur pour mèche 20BH

	d	LT	S	Rot.
B21020	2	38	10	Dx/Sx
B21250	2.5	38	10	Dx/Sx
B21030	3	38	10	Dx/Sx
B21350	3.5	38	10	Dx/Sx

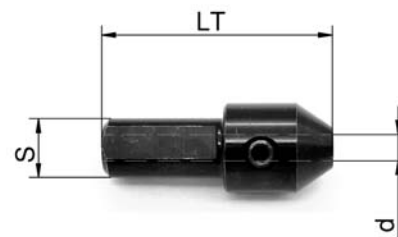

30BD

Broca **PCD - Z2+2** para herrajes
 Mèche **PCD - Z2+2** à façonner

	D	LT	S	Rot.
31BDLD	30	70	10	Dx.
30BDND	35	57.5	10	Dx.
31BDND	35	70	10	Dx.



BROCAS PARA HERRAJES / MÈCHES À FAÇONNER

30BH

Broca corta para herrajes **MD** - Z2+2
Mèche à façonner courte **HM** - Z2+2

	D	LT	S	Rot.
B3020D	20	57	10	Dx.
B3020I	20	57	10	Sx.
B3025D	25	57	10	Dx.
B3025I	25	57	10	Sx.
B3035D	35	57	10	Dx.
B3035I	35	57	10	Sx.
B3040D	40	57	10	Dx.
B3040I	40	57	10	Sx.
B3050D	50	57	10	Dx.
B3050I	50	57	10	Sx.
B3060D	60	57	10	Dx.
B3060I	60	57	10	Sx.

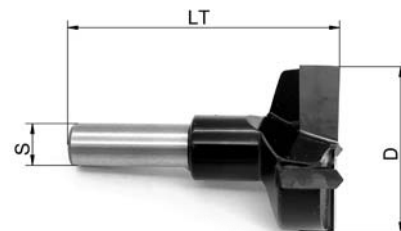

31BH

Broca larga para herrajes **MD** - Z2+2
Mèche à façonner longue **HM** - Z2+2

	D	LT	S	Rot.
B3115D	15	70	10	Dx.
B3115I	15	70	10	Sx.
B3120D	20	70	10	Dx.
B3120I	20	70	10	Sx.
B3125D	25	70	10	Dx.
B3125I	25	70	10	Sx.
B3130D	30	70	10	Dx.
B3130I	30	70	10	Sx.
B3135D	35	70	10	Dx.
B3135I	35	70	10	Sx.
B3140D	40	70	10	Dx.
B3150D	50	70	10	Dx.
B3160D	60	70	10	Dx.

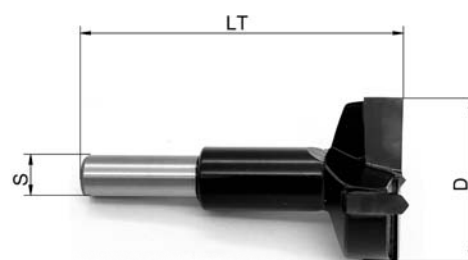

59FM

MD, Cortes múltiples, Rot. Dx. - Hél. pos.
HM, Coupes multiples, Rot. Dx. - Hél. pos.

	D	LC	LT	S
B59CPS03	3	10	45	3
B59CPS04	4	15	60	4
B59CPS05	5	15	60	5
B59CPS06	6	25	70	6
B59CPS08	8	30	80	8
B59CPS10	10	35	80	10
B59CPS12	12	40	90	12

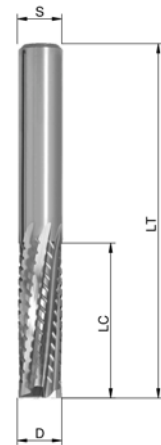

59FM

MD, Cortes múltiples, Rot. Dx. - Hél. neg.
HM, Coupes multiples, Rot. Dx. - Hél. neg.

	D	LC	LT	S
B59CVS03	3	10	45	3
B59CVS04	4	15	60	4
B59CVS06	6	20	70	6
B59CVS08	8	30	80	8
B59CVS10	10	35	80	10
B59CVS12	12	40	90	12

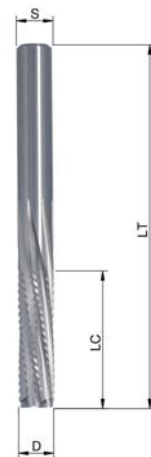

59FM

MD, Cortes múltiples, Rot. Dx. - Axial 0°
HM, Coupes multiples, Rot. Dx. - Axial 0°

	D	LC	LT	S
B59CSS03	3	10	45	3
B59CSS04	4	15	60	4
B59CSS08	8	30	80	8
B59CSS10	10	35	80	10
B59CSS12	12	40	90	12

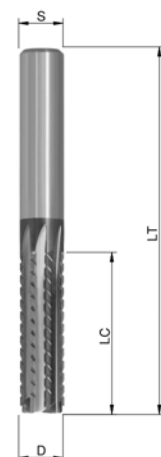

59FM

MD, Esférica cortes múltiples, Rot. Dx. - Hél. pos.
HM, Sphérique coupes multiples, Rot. Dx. - Hél. pos.

	D	LC	LT	S
B59CPU03	3	10	45	3
B59CPU04	4	15	60	4
B59CPU08	8	30	80	8

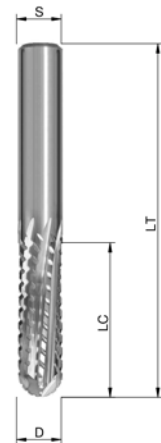
**59FM**

MD, Cortes múltiples, Rot. Dx. - pos./neg.
HM, Coupes multiples, Rot. Dx. - pos./neg.

	D	LC	LT	S
B59CNR04	4	22	60	6
B59CNR06	6	25	70	6
B59CNR08	8	30	80	8
B59CNR10	10	35	80	10

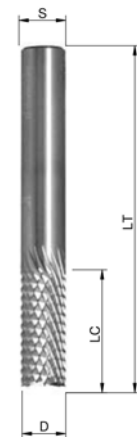
**62FM**

MD, Rot. Dx. (Recubrimiento para alto rendimiento)
HM, Rot. Dx. (Revêtement haut rendement)

	D	LC	LT	S	Z
62FM06HPL	6	15	60	6	2
62FM08HPL	8	15	60	8	2
62FM10HPL	10	15	60	10	2

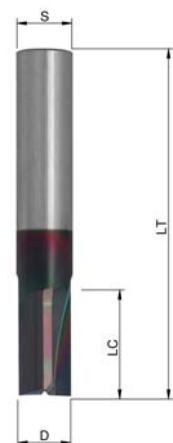

GFK (Plástico reforzado con vidrio)
 CFK (Polímeros reforzados con fibra de carbono)
 HPL (Laminado de papel con resinas fenólicas)
 TEXTOLITE (Fenólico)

GFK (Plastique renforcée de verre)
 CFK (Polymères renforcés de fibres de carbone)
 HPL (Papier stratifié avec résines phénoliques)
 TEXTOLITE (Phénolique)

FRESAS PARA PLEXI, PVC (PLASTICOS) FRAISES POUR PLEXI, PVC (PLASTIQUES)

60FM

MD Rot. Dx. - Hél. pos.
HM Rot. Dx. - Hél. pos.

	D	LC	LT	S	Z
B6003DPP1	3	12	60	3	1
B60031DPP1	3	12	60	6	1
B6004DPP1	4	12	60	4	1
B60041DPP1	4	12	60	6	1
B60042DPP1	4	22	60	6	1
B6006DPP1	6	12	60	6	1
B60061DPP1	6	22	60	6	1
B6008DPP1	8	22	60	8	1
B60081DPP1	8	32	80	8	1
B6010DPP1	10	35	80	10	1

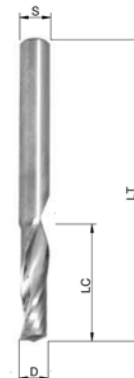

60FM

MD Rot. Dx. - Hél. neg.
HM Rot. Dx. - Hél. neg.

	D	LC	LT	S	Z
B6003DNP1	3	6	60	3	1
B6004DNP1	4	8	60	4	1
B60041DNP1	4	8	60	6	1
B6006DNP1	6	12	60	6	1

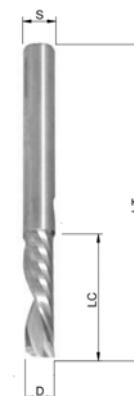

FRESAS PARA ALUMINIO / FRAISES POUR ALUMINIUM

60FM

MD Rot. Dx. - Hél. pos.
HM Rot. Dx. - Hél. pos.

	D	LC	LT	S	Z
B6003DPA1	3	6	60	6	1
B6004DPA1	4	8	60	6	1
B6006DPA1	6	22	60	6	1
B6008DPA1	8	22	60	8	1



FRESAS CON HELICE POS.-NEG. / FRAISES AVEC HÉLICE POS.-NEG.

60FM

MD Rot. Dx. - Hél. pos./neg.
HM Rot. Dx. - Hél. pos./neg.

	D	LC	LT	S	Z
B6050822	8	32	80	8	2+2
B6051022	10	32	80	10	2+2
B6051222	12	42	90	12	2+2
B6051233	12	25	83	12	3+3
B6051622	16	55	110	16	2+2



60FM

MD Dx.- Hél. pos/neg (Recubrimiento alto rendimiento)
HM Dx.- Hél. pos/neg (Revêtement haut rendement)

	D	LC	LT	S	Z
B6050822H	8	22	70	8	2+2
B6051022H	10	25	80	10	2+2
B6051233H	12	25	83	12	3+3
B6051233HL	12	25	80	12	3+3

High Line

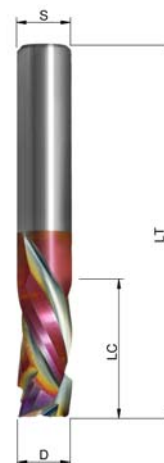

60FM/99

MD Dx.- Hél. pos/neg (Recubrimiento alto rendimiento)
HM Dx.- Hél. pos/neg (Revêtement haut rendement)

	D	LC	LT	S	Z
B609906H	6	22	70	6	2+2
B609908H	8	22	70	8	2+2
B609910H	10	25	80	10	2+2
B609912H	12	25	80	12	2+2
B609916H	16	35	90	16	2+2

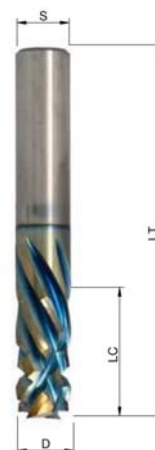

FRESAS MD INTEGRAL (ACABADO) FRAISES HM MONOBLOC Á DÉFONCER (FINITION)

60FM

MD Dx. - Hél. pos.
HM Dx. - Hél. pos.

	D	LC	LT	S	Z
B6003DP2	3	12	50	3	2
B6004DP2	4	15	50	4	2
B6005DP2	5	17	50	5	2
B6006DP2	6	27	70	6	2
B6008DP2	8	32	80	8	2
B6010DP2	10	32	80	10	2



60FM

MD Dx. - Hél. pos.
HM Dx. - Hél. pos.

	D	LC	LT	S	Z
B6008DP3	8	32	80	8	3
B6010DP3	10	32	80	10	3
B60102DP3	10	42	90	10	3
B6012DP3	12	35	83	12	3
B60122DP3	12	42	90	12	3
B6014DP3	14	58	110	14	3
B6016DP3	16	55	110	16	3
B60202DP3	20	70	120	20	3



60FM

MD (Radio) Dx. - Hél. pos.
HM (Sphérique) Dx. - Hél. pos.

	D	LC	LT	S	Z	R
B6006R3	6	27	70	6	2	3
B6008R4	8	32	80	8	2	4
B6010R5	10	32	80	10	2	5
B6012R6	12	35	80	12	2	6
B6016R8	16	55	110	16	2	8

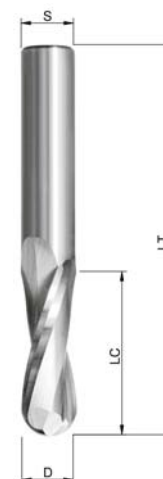

60FM

MD Dx. - Hél. neg.
HM Dx. - Hél. neg.

	D	LC	LT	S	Z
B6003DN2	3	12	50	3	2
B6004DN2	4	15	50	4	2
B6005DN2	5	17	50	5	2
B6006DN2	6	27	70	6	2
B6008DN2	8	32	80	8	2
B6010DN2	10	32	80	10	2

**60FM**

MD Dx. - Hél. neg.
HM Dx. - Hél. neg.

	D	LC	LT	S	Z
B6010DN3	10	32	80	10	3
B60102DN3	10	42	90	10	3
B6012DN3	12	35	83	12	3
B60142DN3	14	50	110	14	3
B6016DN3	16	55	110	16	3
B60202DN3	20	60	120	20	3

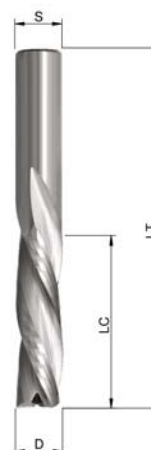
**62FM**

MD Dx. Axial 0°
HM Dx. Axial 0°

	D	LC	LT	S	Z
B62M03	3	10	60	6	2
B62M04	4	15	60	6	2
B62M06	6	20	60	6	2
B62M08	8	25	70	8	2



FRESAS MD INTEGRAL (desbaste) FRAISES HM MONOBLOC À DÉFONCER (ébauche)

61FM

MD Dx. - Hél. pos.

HM Dx. - Hél. pos.

	D	LC	LT	S	Z
B6108DP3	8	32	80	8	3
B6110DP3	10	32	80	10	3
B61102DP3	10	42	90	10	3
B6112DP3	12	35	83	12	3
B61122DP3	12	42	90	12	3
B61142DP3	14	42	100	14	3
B6116DP3	16	55	110	16	3
B61162DP3	16	72	120	16	3
B6120DP3	20	60	120	20	3
B61202DP3	20	72	120	20	3



61FM

MD Dx. - Hél. neg.

HM Dx. - Hél. neg.

	D	LC	LT	S	Z
B6108DN3	8	32	80	8	3
B61102DN3	10	42	90	10	3
B61122DN3	12	42	90	12	3
B6114DN3	14	50	110	14	3
B61162DN3	16	55	110	16	3
B61202DN3	20	72	120	20	3



61FM

MD Dx. - Hél. pos. (cerraduras)

HM Dx. - Hél. pos. (serrures)

	D	LC	LT	S	Z
B611420DP3	14	45 / 95	150	14	3
B611645DP3	16	45 / 95	150	16	3
B611845DP3	18	45 / 95	150	18	3

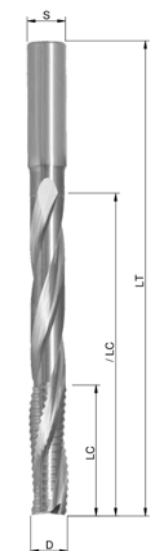

FRESAS Peanut, Lamello, Alucobond
FRAISES Peanut, Lamello, Alucobond

31FM

MD Dx., Peanut
HM Dx., Peanut

	D	LC	LT	S	Z
FM31P12	12	12	90	12	2



31FM

MD Dx., Lamello
HM Dx., Lamello

	D	LC	LT	S	Z
FM31L9	9.8	25	80	12	2



40FM

MD Dx., Alucobond
HM Dx., Alucobond

	D	LC	LT	S	Z	Ang.
40FM1690	16	15	60	12	2	90°
40FM18135	18	15	60	12	2	135°

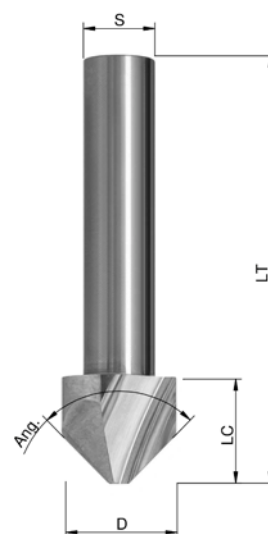

62FD

PCD Dx. Z1+1

	D	LC	LT	S	Cuerpo/Corp	Axial
62FD08DEN	8	20	75	12	Densimet	Pos/Neg
62FD10DEN	10	20	65	12	Densimet	Pos/Neg
62FD12DEN	12	20	66	12	Densimet	Pos/Neg
62FD20DEN	20	25	86	20	Acero/Acier	Pos/Neg

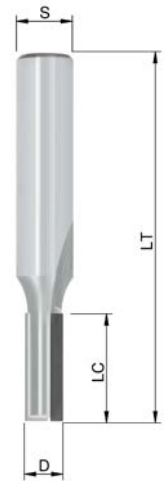

62FD

PCD Dx.

	D	LC	LT	S	Cuerpo/Corp	Z	Axial
62FD06	6	12	70	6	MD / HM	1	Neg.
62FD08	8	20	70	8	MD / HM	1	Neg.
62FD082	8	20	70	8	MD / HM	2	Neg.
62FD10	10	15	75	10	MD / HM	1	Neg.
62FD102	10	25	75	10	MD / HM	2	Neg.
62FD12	12	35	85	12	MD / HM	2	Neg.

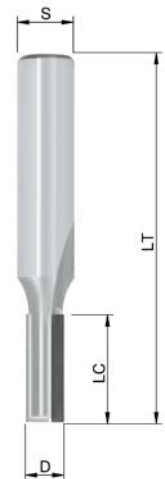

01DIP

PCD H3 Dx. (Pasante)
PCD H3 Dx. (Débouchante)

	D	LC	LT	S	Z
H01PAB	10	27	80	12	1 + 1
H01PBD	12	36	91	12	1 + 1
H01PDD	16	36	102	16	1 + 1

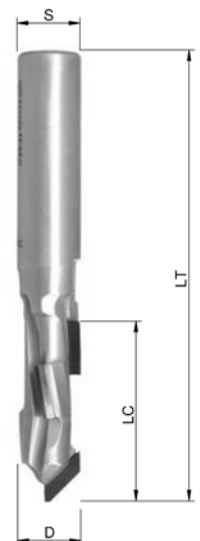

01DI

PCD H2.5 Dx. (Placa frontal MD)
PCD H2.5 Dx. (Plaque frontale HM)

	D	LC	LT	S	Z
H01DIAB	10	25	75	12	1 + 1
H01DIBA	12	25	75	12	1 + 1
H01DIBD	12	35	95	12	1 + 1
H01DIDD	16	35	95	16	1 + 1
H01DIDG	16	45	103	16	1 + 1
H01DIEA	18	25	85	20	1 + 1
H01DILE	20	45	103	20	1 + 1
H01DIMA	20	55	125	20	1 + 1

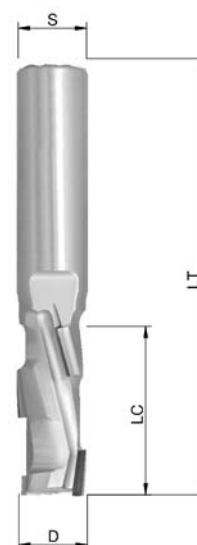

03DI

PCD H2.5 Dx. (Placa frontal MD)
PCD H2.5 Dx. (Plaque frontale HM)

	D	LC	LT	S	Z
03DIA2	12	25	78	12	2 + 2
03DIA3	16	25	85	20	2 + 2
03DIB3	16	35	94	20	2 + 2
03DIA4	18	35	97	20	2 + 2
03DIA5	20	25	85	20	2 + 2
03DIB4	20	35	94	20	2 + 2
03DIC4	20	45	103	20	2 + 2
03DID4	20	55	112	20	2 + 2



02DI

PCD H4.5 Dx. (Placa frontal PCD)
PCD H4.5 Dx. (Plaque frontale PCD)

	D	LC	LT	S	Z
02DIBA	20	35	95	20	3 + 3
02DICA	20	45	105	20	3 + 3
02DIED	25	35	102	25	3 + 3
02DIFA	25	45	110	25	3 + 3

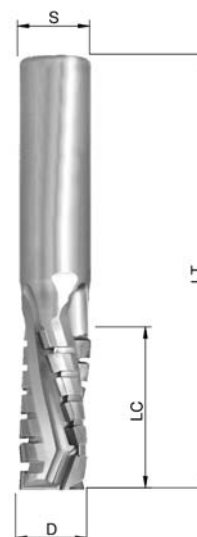

02DI

Fresas **PCD** para NESTING
Fraises **PCD** pour NESTING

02DI **PCD** NESTING Rot. Dx. - Z3+3 H3

	D	LC	LT	S
02DIN12I	12	24	70	12
02DIN1635I	16	35	91	16

Recomendado para aglomerado
Recommandé pour les agglomérés



02DI

Fresas **PCD** para NESTING
Fraises **PCD** pour NESTING

02DI **PCD** NESTING Rot. Dx. - Z3 H3

	D	LC	LT	S
02DIN12D	12	25	75	12

Recomendado para DM
Recommandé pour MDF

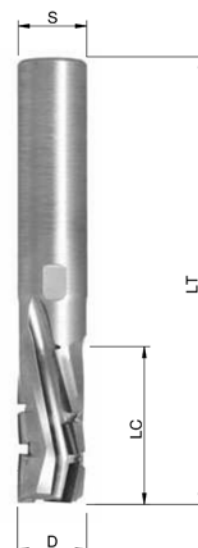

60FM/99

MD Dx., Hél. pos/neg (Recubrimiento alto rendimiento)
HM Dx., Hél. pos/neg (Revêtement haut rendement)

	D	LC	LT	S	Z
B609910H	10	25	80	10	2+2
B609912H	12	25	80	12	2+2
B609916H	16	35	90	16	2+2

Recomendado para DM bruto
Recommandé pour MDF brut

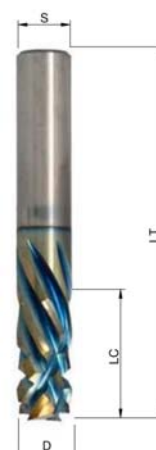

05CB

Cabezas **MD** para planear
 Porte-outils **HM** à surfacer

Rot. Dx.

	D	LC	LT	S	Z
C055AM	60	12	80	20	3
C056AM	80	12	80	20	3
C054AM	100	12	80	20	3

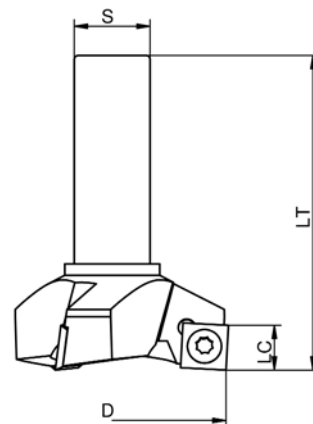
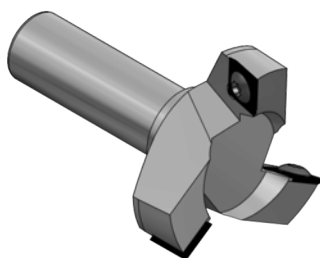
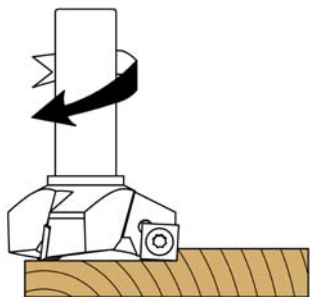

05FD

Fresas **PCD** para planear
 Fraises **PCD** à surfacer

Rot. Dx.

	D	LC	LT	S	Z
FD055AM	60	10	80	20	4
FD054AM	100	10	80	20	4

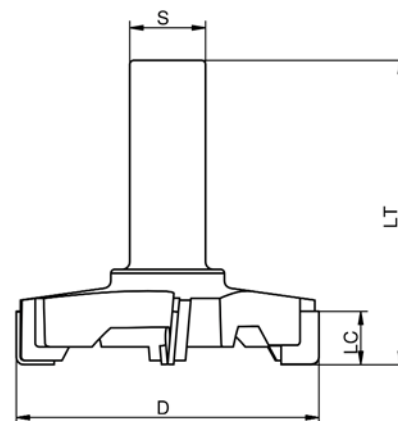
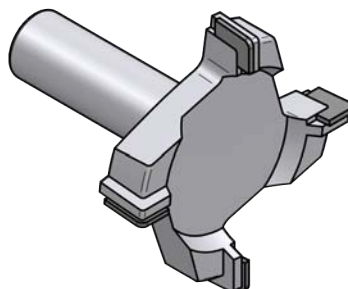
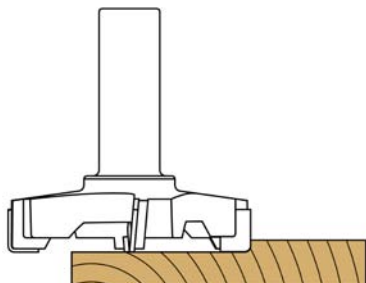

CABEZALES PARA TALADRAR Y CONTORNEAR PORTE-OUTILS À DÉFONCER

71FM

Cabezales **MD** para taladrar y contornear
Porte-outils **HM** à défoncer

Rot. Dx.

	D	LC	LT	S	Z
B71B165	16	50	105	20	2 + 1
B71B205	20	50	105	20	2 + 1

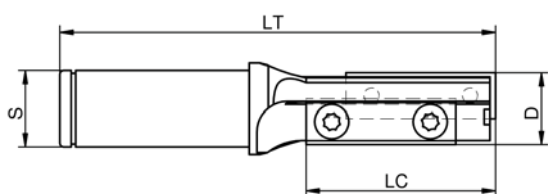

72FM

Cabezales **MD** para taladrar y contornear
Porte-outils **HM** à défoncer

Rot. Dx.

	D	LC	LT	S	Z
B723030	30	29.5	100	20	2 + 1
B723050	30	49.5	120	20	2 + 1

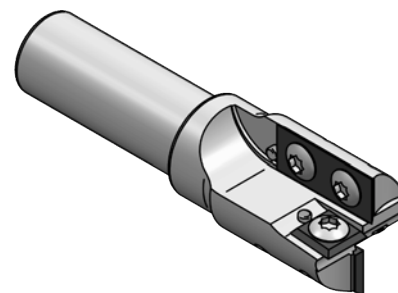
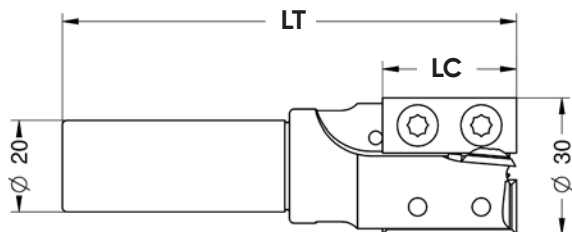

08CB

Cabezales **MD** para galces , canteado
Porte-outils **HM** à dresser

Rot. Dx.

	D	LC	LT	S	Z
C082AM	60	50	110	20	Z2 V2
C083AM	60	50	110	20	Z3 V3

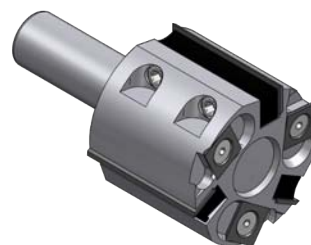
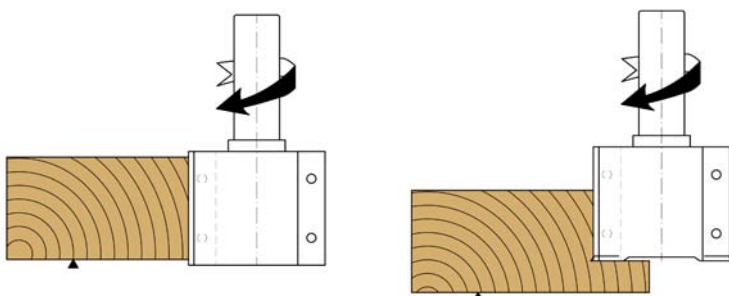
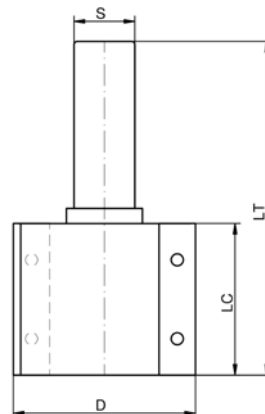

69FM

Cabezales **MD** para cerraduras
Porte-outils **HM** logement de serrures

Rot. Dx. (Cuerpo densimet, corp densimet)

	D	LC	LT	S	Z
B6916A	16	16 / 90	150	16	2 + 1
B6916B	16	23 / 105	150	16	2 + 1
B6916C	16	28 / 105	150	16	2 + 1

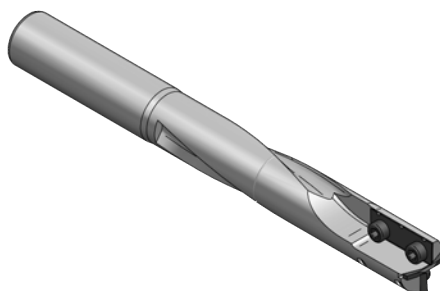
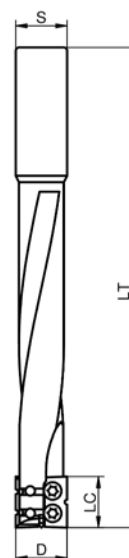

39FD

Fresas angulares **PCD** Rot. Dx.
 Fraises angulaires **PCD** Rot. Dx.

	D	LC	S	Z	Ang.
FD3930	30	15	20	1+1	90°
FD3950	50	25	20	1+1	90°

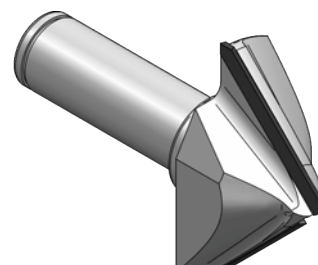
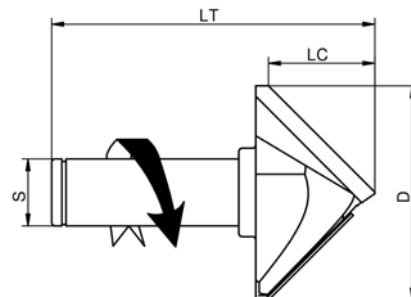
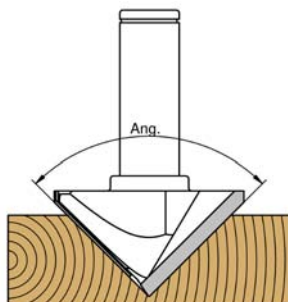
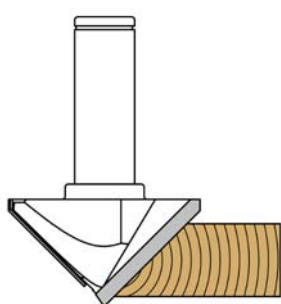

77CB

Cabezales **MD** multiperfil Rot. Dx.
 Porte-outils **HM** multi-profil Rot. Dx.

	D	L. Util	S	Z
C772AM	24	12	20	1
C772BM	22	11	20	1

* Los cabezales se sirven con cuchillas de 45° (según dibujos)

* Les porte-outils sont servis avec plaquettes de 45°

**CUCHILLAS ESPECIALES
 PLAQUETTES SPÉCIALES**

Medidas *Dimensions*

C772AM.001

23 x 12 x 1.5

C772BM.002

23 x 12 x 1.5

Pedido mínimo: 2 unidades

Commande minimum: 2 unités

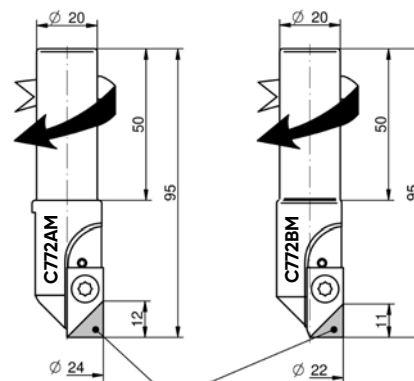

Zona para el perfil.
 Zone du profil.

CABEZALES PARA BISELADO / FOLDING
PORTE-OUTILS POUR CHANFREINER / FOLDING

76FM

Cabezal **MD** (90° / 91°) Rot. Dx.
 Porte-outil **HM** (90° / 91°) Rot. Dx.

BISEL/CHANFREIN 45°	D	LC	S	Z	Ang.
B7665D	65	32	20	1	90°

FOLDING 45.5°	D	LC	S	Z	Ang.
B76652	65	32	20	1	91°

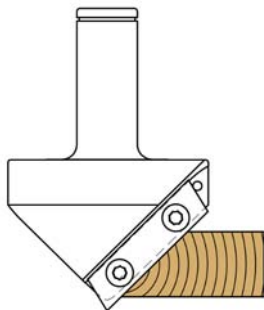
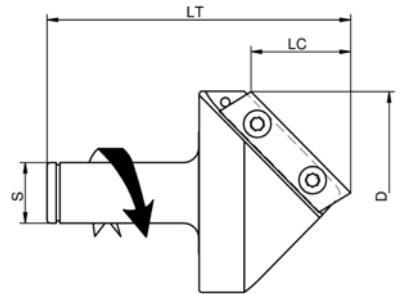

**BISELAR
CHANFREINER**

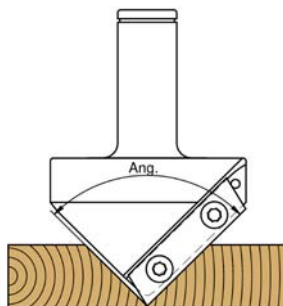

FOLDING



REPUESTOS / RECHANGES	L	H	E
CU1F065	49.5	12	1.5

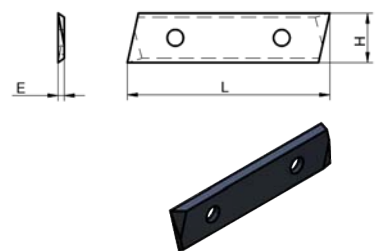

FRESAS/CABEZALES PARA UÑEROS FRAISES/PORTE-OUTILS POUR POIGNÉES DE PORTE

82FR

Fresas **MD** para uñeros, Rot. Dx.
Fraises **HM** pour poignées de porte, Rot. Dx.

	Perfil/Profil	D	LC	S	Z
F821AM	81/1	60	20	20	2
F822BM	81/2	60	25	20	2
F823CM	81/3	60	20	20	2
F824DM	81/4	60	20	20	2
F825EM	81/5	60	20	20	2
F826FM	81/6	60	25	20	2

82FD

Fresas **PCD** para uñeros, Rot. Dx.
Fraises **PCD** pour poignées de porte, Rot. Dx.

	Perfil/Profil	D	LC	S	Z
FD821AM	81/1	60	20	20	2
FD822BM	81/2	60	25	20	2
FD823CM	81/3	60	20	20	2
FD824DM	81/4	60	20	20	2
FD825EM	81/5	60	20	20	2
FD826FM	81/6	60	25	20	2

82CB

Cabezales **MD** para uñeros, Rot. Dx.
Porte-outils **HM** pour poignées de porte, Rot. Dx.

	Perfil/Profil	D	LC	S	Z
C821AM	81/1	60	20	20	2
C822BM	81/2	60	25	20	2
C823CM	81/3	60	20	20	2
C824DM	81/4	60	20	20	2
C825EM	81/5	60	20	20	2
C826FM	81/6	60	25	20	2

PERFILES NORMALIZADOS PROFILS STANDARDS

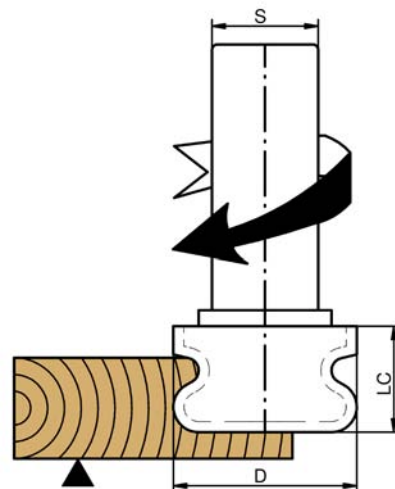
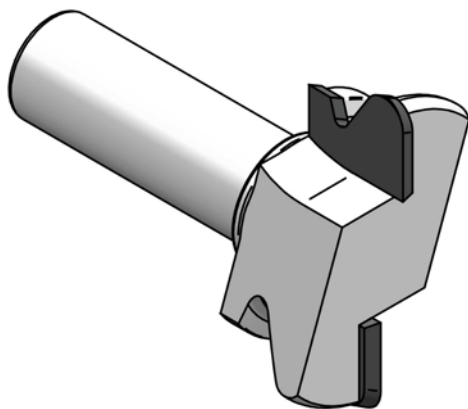
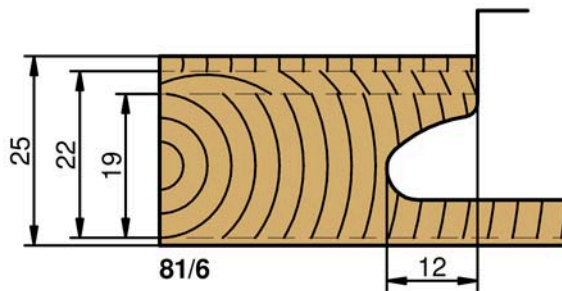
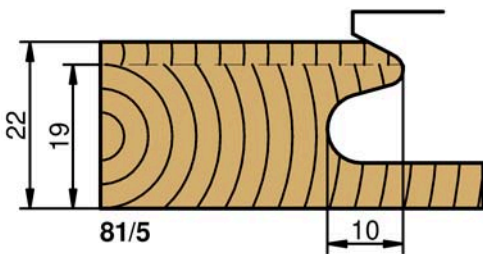
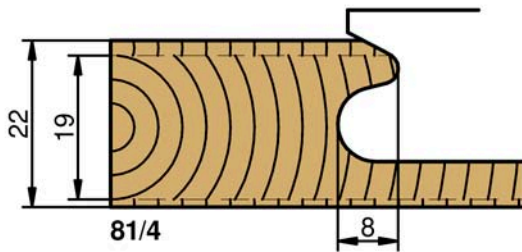
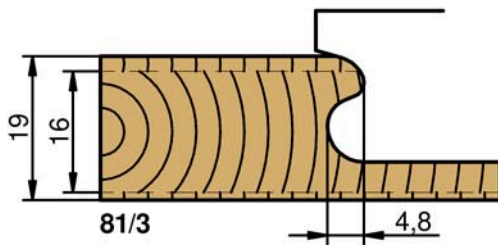
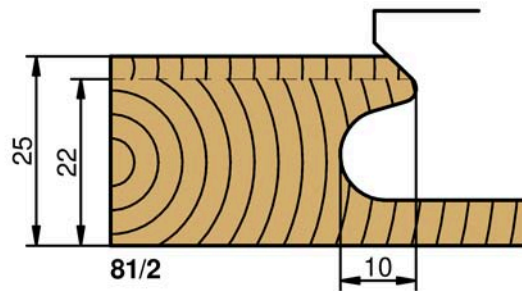
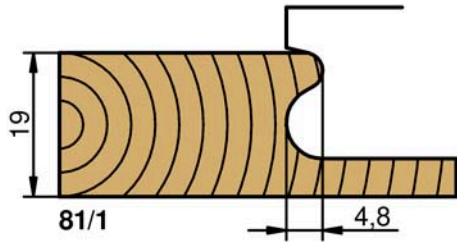

01FR

Fresas **MD** rectas sin axial
Fraises **HM** droites sans angle axial

	D	LC	d	Z
F063AM	140	4	50	8
F063BM	140	5	50	8
F063EM	140	8	50	8
F063GM	140	10	50	8
F011EM	140	20	50	4
F011FM	140	30	50	4
F011GM	140	40	50	4
F011HM	140	50	50	4

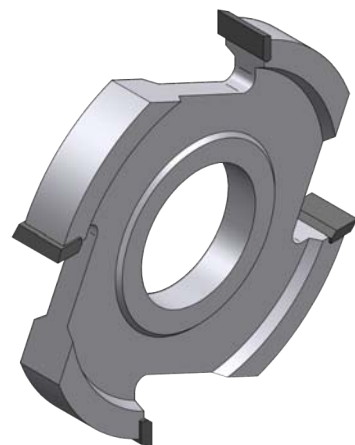
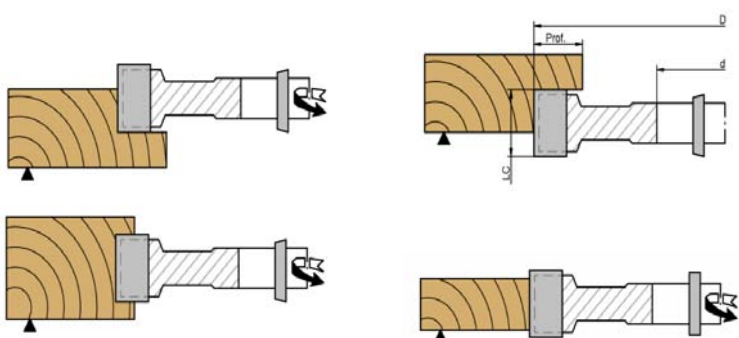

03FR

Fresas **MD** rectas con precortadores
Fraises **HM** droites avec araseurs

	D	LC	d	Z
F092AM	140	4	50	Z4 V2+2
F092BM	140	5	50	Z4 V2+2
F092EM	140	8	50	Z4 V2+2
F092GM	140	10	50	Z4 V2+2
F031FM	140	30	50	Z4 V2+2
F031HM	140	50	50	Z4 V2+2

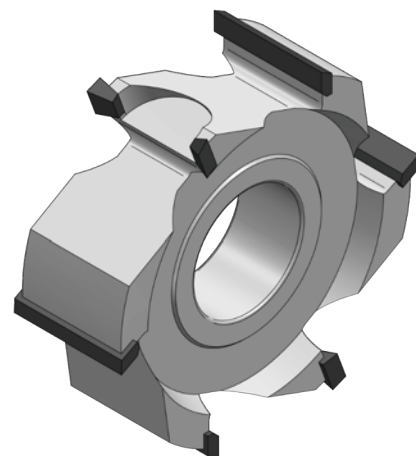
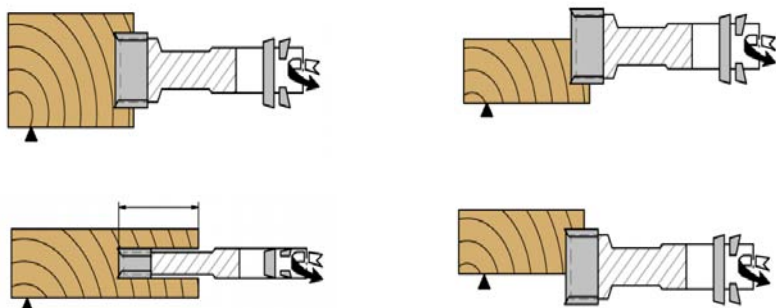

01CB

Cabezales **MD** rectos con precortadores
 Porte-outils **HM** droits avec araseurs

	D	LC	d	Z
C161AM	140	8	50	Z4 V2+2
C165AM	140	10	50	Z4 V2+2
C164AM	160	20.4	50	Z4 V2+2
C013AM	125	30.4	50	Z4 V2+2
C014AM	125	50.4	50	Z4 V2+2

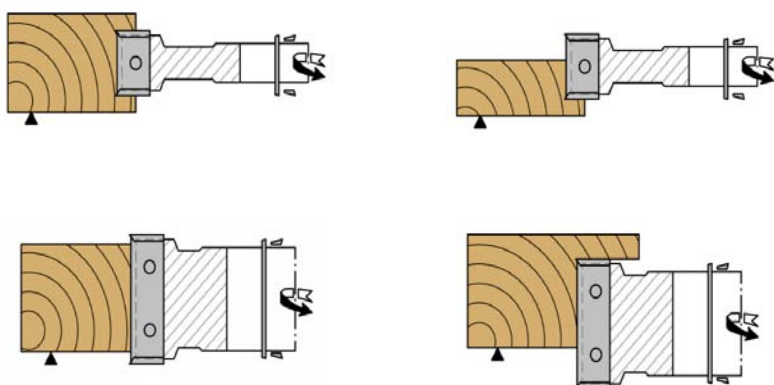

06CB

Cabezales **MD** rectos
 Porte-outils **HM** droits

	D	LC	d	Z
C06T1A	125	30	50	4
C06T2A	125	50	50	4

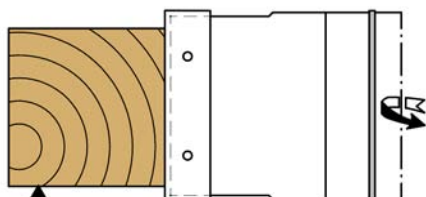

13FR

Fresas MD extensibles
Fraises PCD extensibles

	D	LC	d	Z	L1
F134AM	140	4/7.5	50	Z2+2 V2+2	22
F134BM	140	7/13.5	50	Z2+2 V2+2	22
F134CM	140	10/19.5	50	Z2+2 V2+2	22
FO41EM	160	15/29.5	50	Z2+2 V2+2	43
FO41FM	160	30/59.5	50	Z2+2 V2+2	43

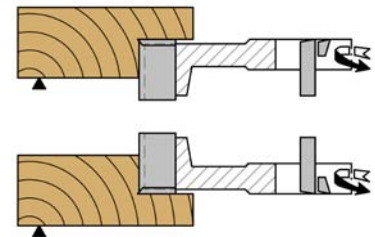
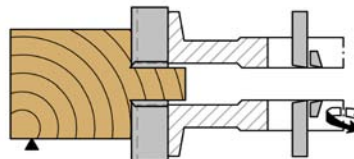
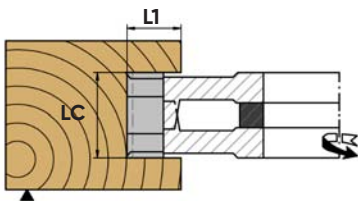
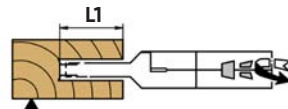
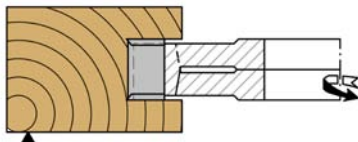
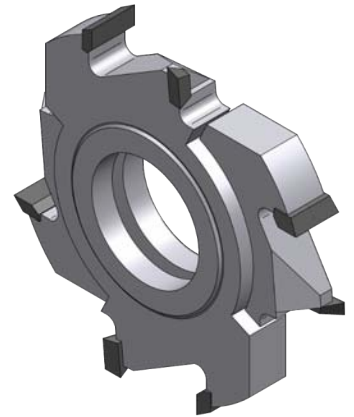

20CB

Cabezales MD extensibles
Porte-outils HM extensibles

	D	LC	d	Z	L1
C201AM	160	8/15.5	50	Z2+2 V2+2	35
C201BM	160	10/19.5	50	Z2+2 V2+2	35
C202AM	160	12.4/24	50	Z2+2 V2+2	35
C031AM	160	20.4/40	50	Z2+2 V2+2	43
C032AM	160	30.4/60	50	Z2+2 V2+2	43

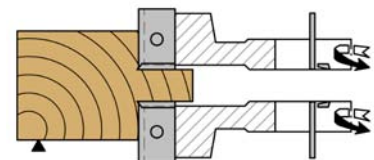
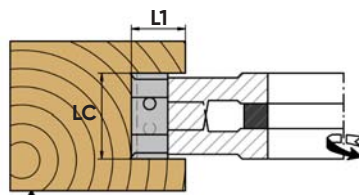
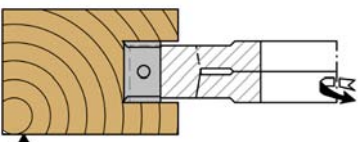
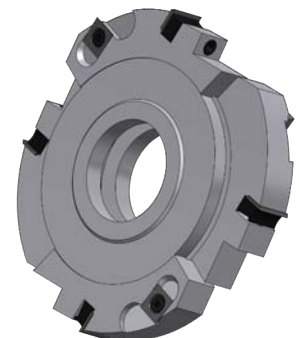

19FR

Fresas **MD** para biselar
Fraises **HM** à chanfreiner

	D	LC	d	Ang.	Z	Pos.
F196BM	160	30	50	45°	4	19/1
F196BMS	160	30	50	45°	4	19/2

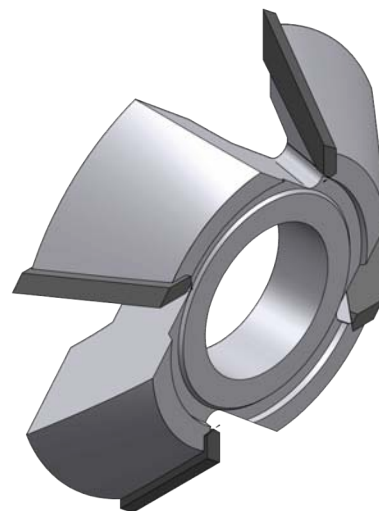
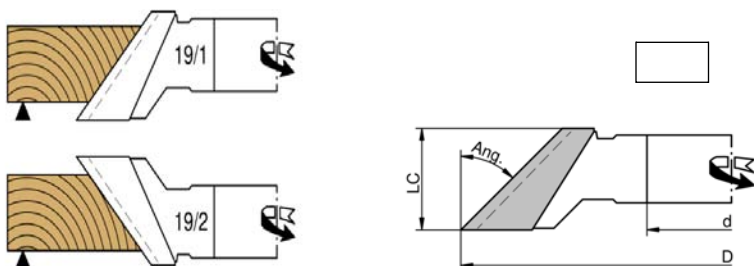

20FR

Fresas **MD** para cortes en "V"
Fraises **HM** pour coupes en "V "

	D	LC	d	Ang.	Z
FR2030	140	30	50	90°	4
FR2040	140	40	50	90°	4

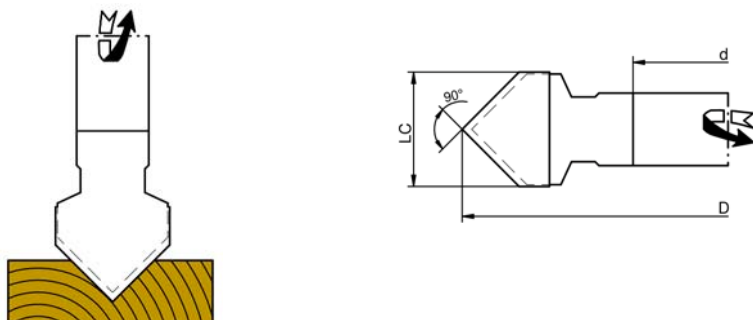

FRESAS/CABEZALES PARA JUNTAS FRAISES/PORTE-OUTILS POUR BOUVETAGE

21FR

Fresas **MD** para juntas a inglete
Fraises **HM** pour bouvetage d'angle

	D	LU	d	Z
F211AM	150	10 - 20	50	4
F212BM	180	18 - 36	50	4

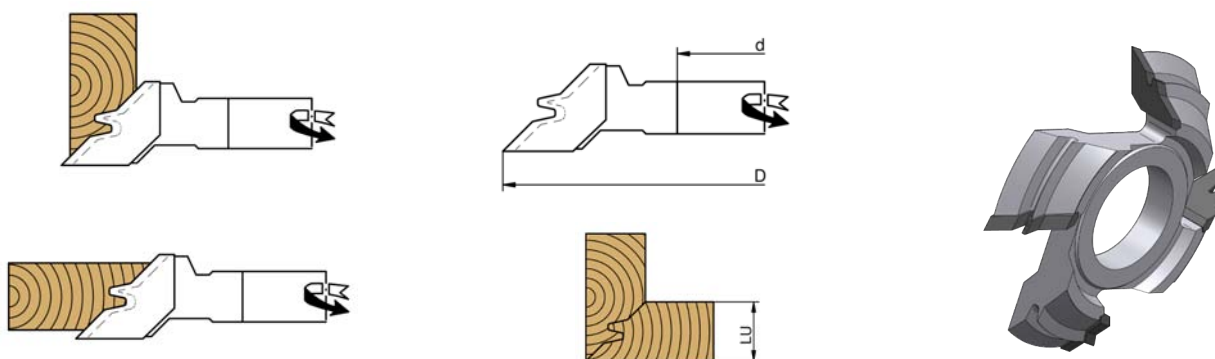

49CB

Cabezal **MD** para juntas a inglete
Porte-outil **HM** pour bouvetage d'angle

	D	LU	d	Z
C491AM	180	16 - 32	50	Z4 Ran2+2

REPUESTOS/RECHANGES	Medidas/Dimensions
C491AMC0	Cuchilla/Plaque 50 x 12 x 1.5
CU313IM	Ranurador/Rainer 16 x 34 x 4
CU313JM	Ranurador/Rainer 16 x 34 x 5

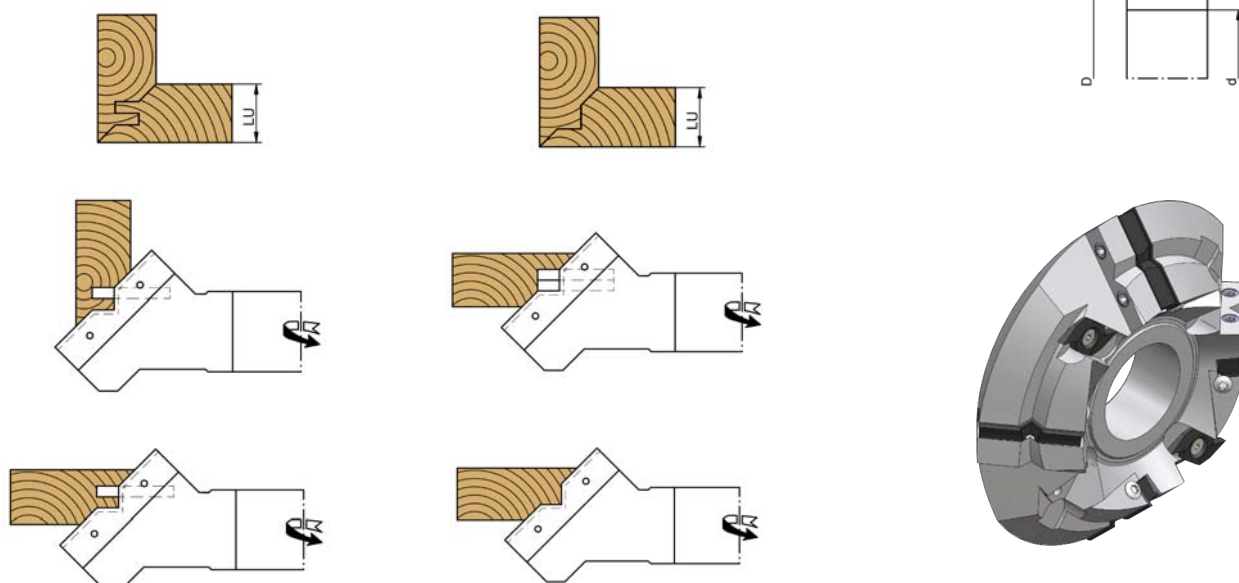

29FR

Fresas HSS apilables para microensambles Fraises HSS pour joints collés empilables

	Perfil	D	LC	d	Z
F292BH	29/2	160	28.6	50	2+2
F293CH	29/3	170	28.6	50	2+2
F292DH	29/2	250	28.6	50	3+3
F293EH	29/3	260	28.6	50	3+3

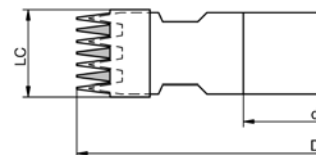

FRESAS NECESARIAS SEGUN ANCHO DE MADERA FRAISES NECESSAIRES SELON LARGUEUR DU BOIS

ANCHO DE MADERA LARGUEUR DU BOIS	NUMERO DE FRESAS NUMERO DE FRAISES
24	1
51	2
77	3
104	4
131	5
157	6
184	7
210	8
237	9
264	10

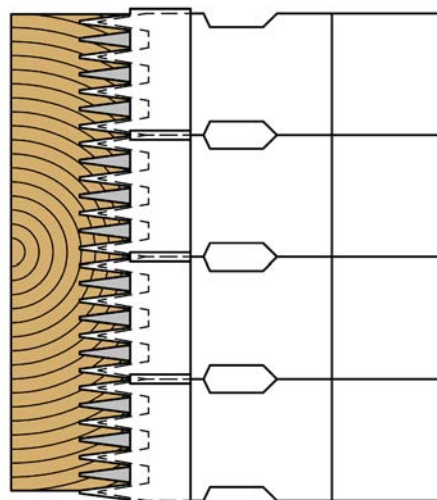
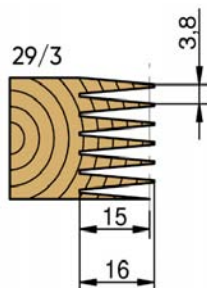
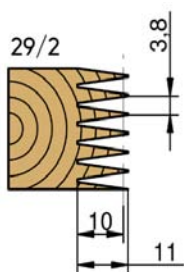
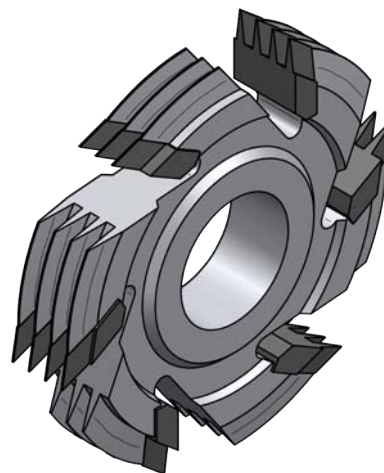

28FR

Fresas para juntas encoladas
Fraises pour joints collés

MD /HM	Paso/Pas	Perfil/Profil	D	LC	d	Z
F281AM	6	28/1	140	40	50	4
F281BM	6	28/1	140	85	50	4
F282CM	4	28/2	140	40	50	4
F282DM	4	28/2	140	85	50	4

HSS	Paso/Pas	Perfil/Profil	D	LC	d	Z
F281AH	6	28/1	140	40	50	4
F281BH	6	28/1	140	85	50	4
F282CH	4	28/2	140	40	50	4
F282DH	4	28/2	140	85	50	4

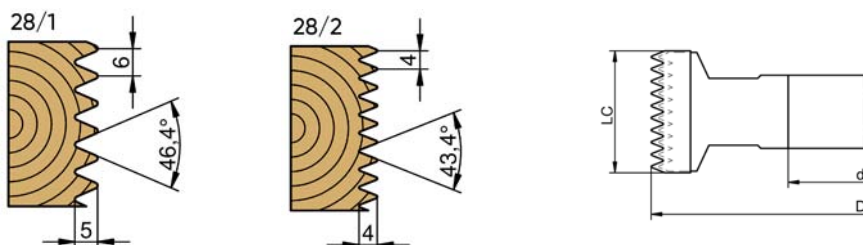
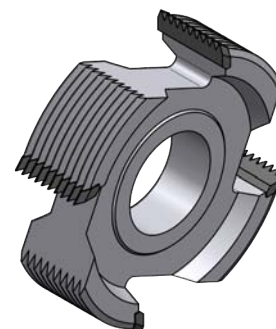

50CB

Cabezal MD para juntas encoladas
Porte-outil HM pour joints collés

	Paso/Pas	Perfil/Profil	D	LC	d	Z
C501AM	4	50/1	125	50	50	2
C501BM	4	50/1	125	80	50	2

REPUESTOS/RECHANGES	Medidas/Dimensions
CU15A1	50 x 12 x 1.5
CU15B1	80 x 13 x 2.2

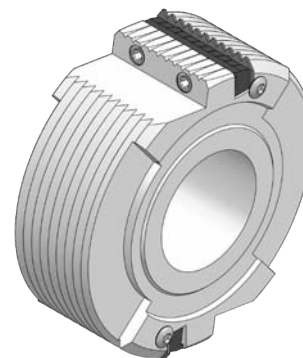
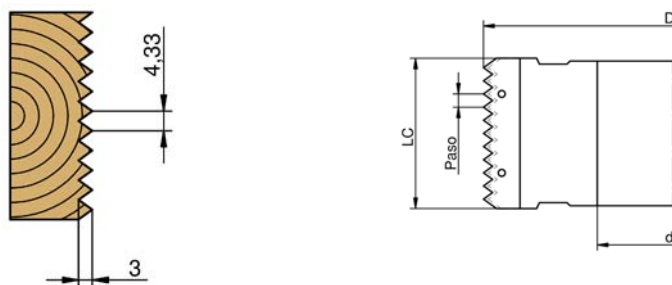

27FR

Fresas para juntas, espesor variable Fraises pour joints, épaisseur variable

	Ref.	D	LC	d		Z
F271AH	27/A	140	14	50	HSS	3
	27/B	140	85	50	HSS	3
F271AM	27/A	140	14	50	MD/HM	3
	27/B	140	85	50	MD/HM	3

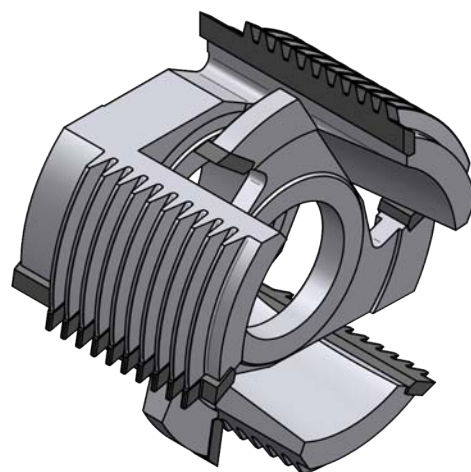
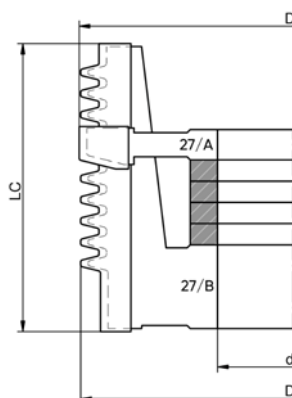
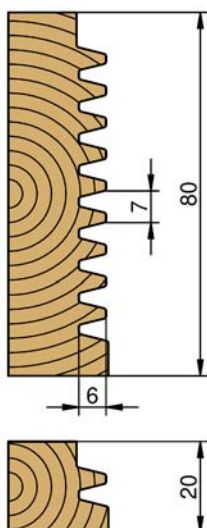

51CB

Cabezales MD para juntas, espesor variable Porte-outils HM pour joints, épaisseur variable

	Ref.	D	LC	d	Z
C510AM	51/A	160	74	50	3
	51/B	161	15	50	3

REPUESTOS/RECHANGES

Descripción/Description

CU15F0

Cuchillas/Plaquettes 51/A (74 x 24 x 2)

CU15G1

Cuchillas/Plaquettes 51/B (16 x 16 x 2)

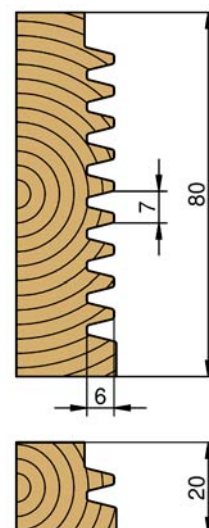
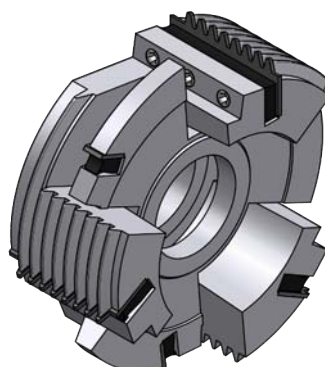
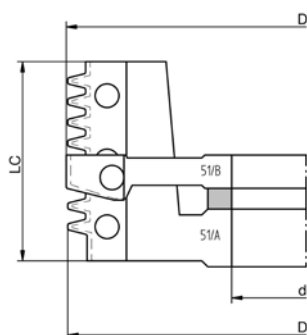

CABEZALES MACHIHEMRADO PORTE-OUTILS À RAINURE-LANGUETTE

55CB

Juego cabezales **MD Z3** para machihembrado
Jeu Porte-outils **HM Z3** à rainure-languette

		TIPO DE JUNTA / TIPE DE JOINT						
		Prfl. 55/1	Prfl. 55/2	Prfl. 55/4	Prfl. 55/5	Prfl. 55/6	Prfl. 55/7	Prfl. 55/9
DIAM. REF. (D)	160	55CB.001	55CB.002	55CB.004	55CB.005	55CB.006	55CB.007	55CB.009

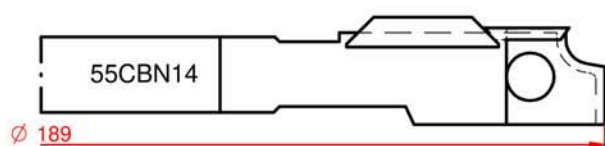
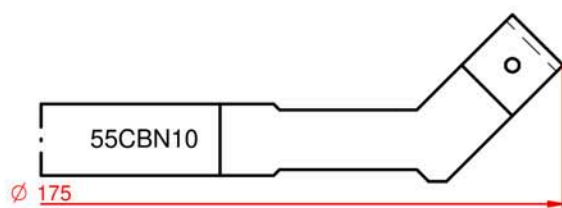
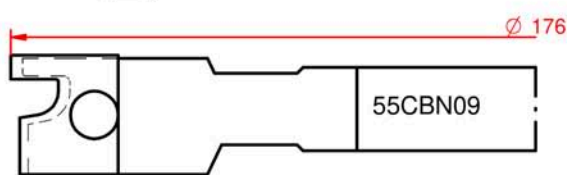
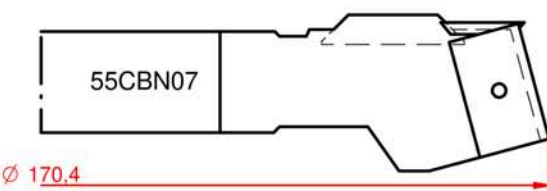
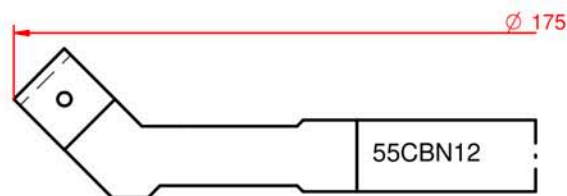
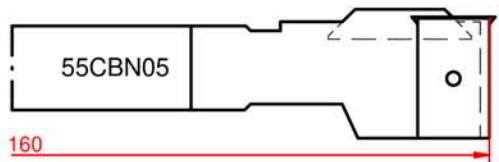
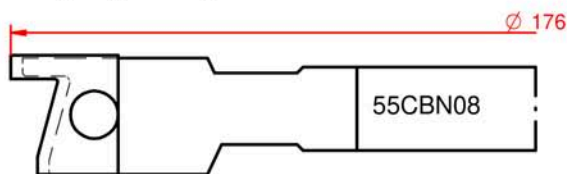
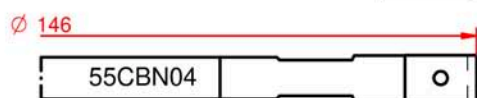
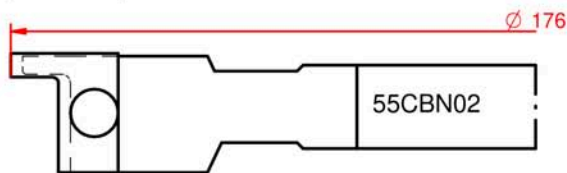
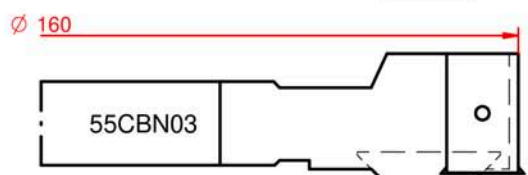
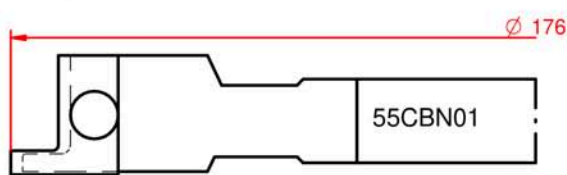
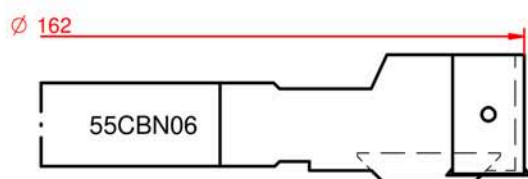
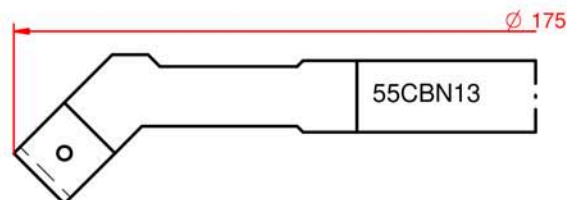
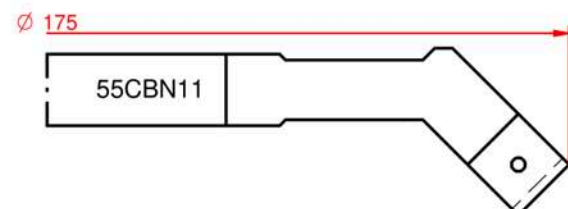

**CADA JUEGO DE HERRAMIENTAS SE
SERVIRA MONTADO EN SUS
CORRESPONDIENTES MANGUITOS**

**CHAQUE JEU D'OUTILS SERA FOURNI
MONTÉ SUR LE MANCHON
CORRESPONDANT.**

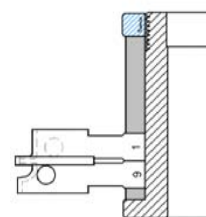
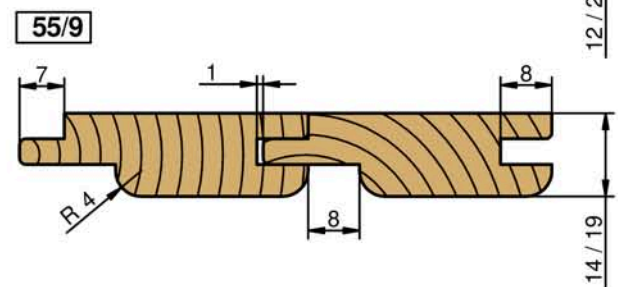
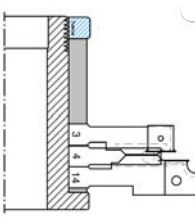
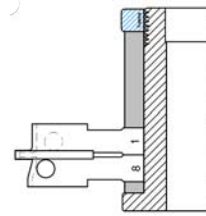
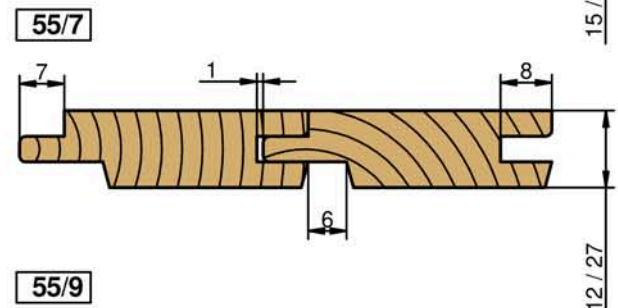
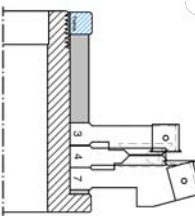
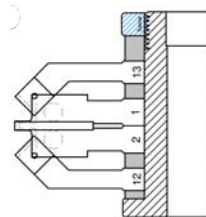
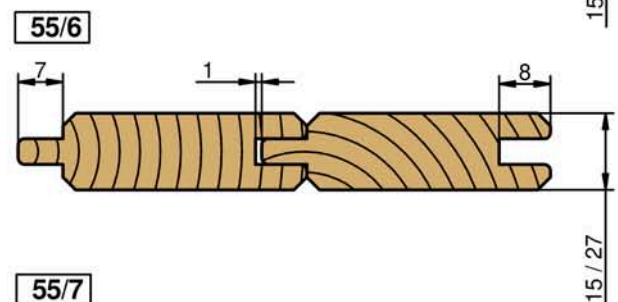
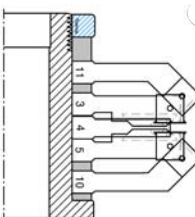
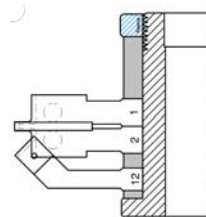
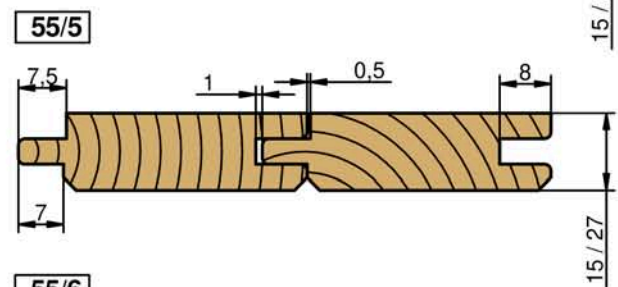
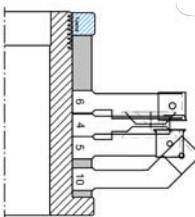
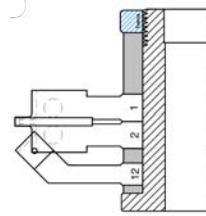
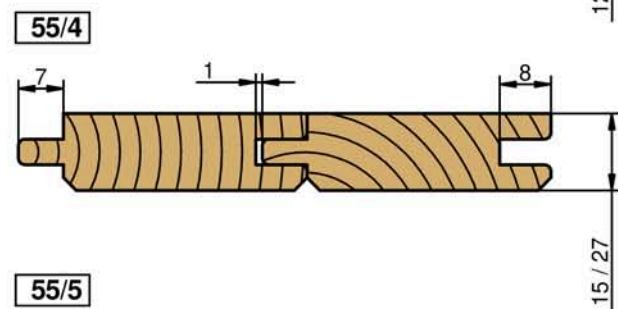
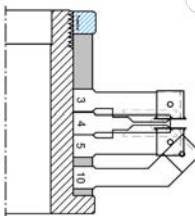
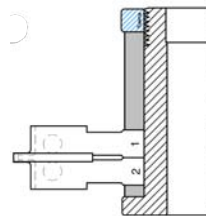
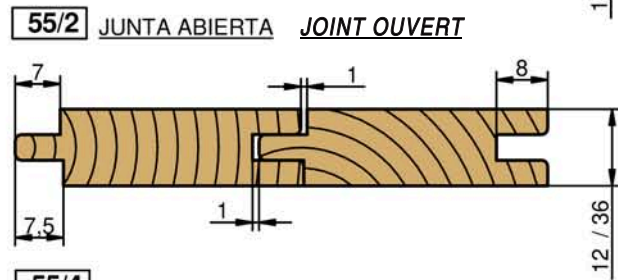
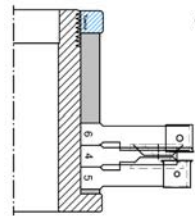
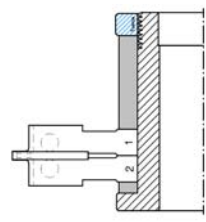
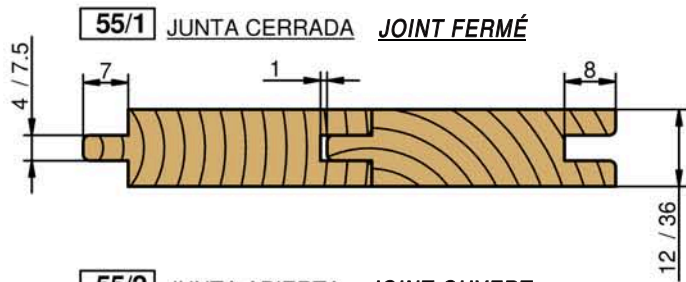
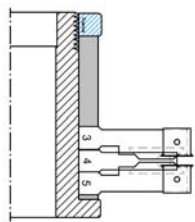

81FR

Fresas **MD** para uñeros
 Fraises **HM** pour poignées de porte

	Perfil/Profil	D	LC	d	Z
F811AM	81/1	160	20	50	4
F812BM	81/2	160	25	50	4
F813CM	81/3	160	20	50	4
F814DM	81/4	160	20	50	4
F815EM	81/5	160	20	50	4
F816FM	81/6	160	25	50	4

81CB

Cabezales **MD** para uñeros
 Porte-outils **HM** pour poignées de porte

	Perfil/Profil	D	LC	d	Z
C811AM	81/1	160	20	50	4
C812BM	81/2	160	25	50	4
C813CM	81/3	160	20	50	4
C814DM	81/4	160	20	50	4
C815EM	81/5	160	20	50	4
C816FM	81/6	160	25	50	4

81FD

Fresas **PCD** para uñeros
 Fraises **PCD** pour poignées de porte

	Perfil/Profil	D	LC	d	Z
FD811AM	81/1	160	20	50	4
FD812BM	81/2	160	25	50	4
FD813CM	81/3	160	20	50	4
FD814DM	81/4	160 </td <td>20</td> <td>50</td> <td>4</td>	20	50	4
FD815EM	81/5	160	20	50	4
FD816FM	81/6	160	25	50	4

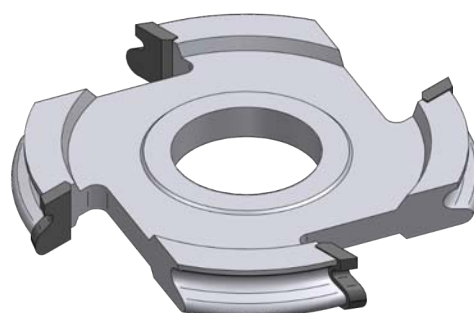
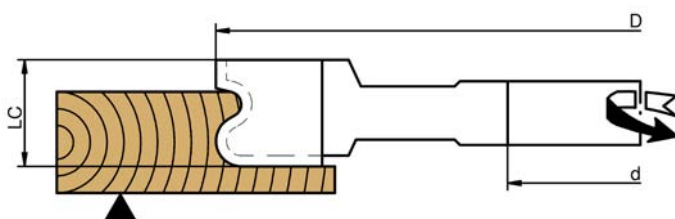

PERFILES NORMALIZADOS PROFILS STANDARDS

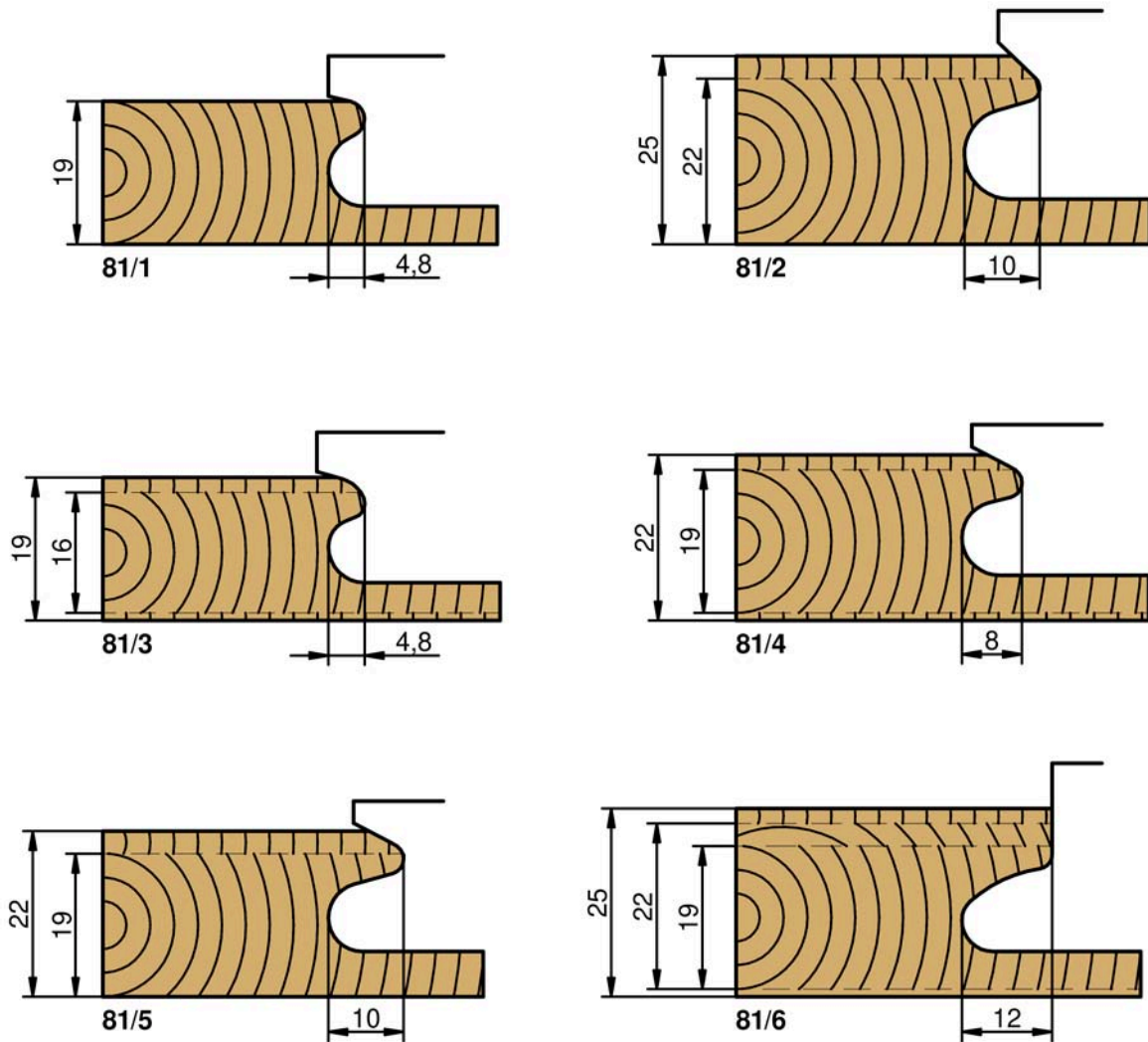

POSICION DE TRABAJO POSITION DE TRAVAIL

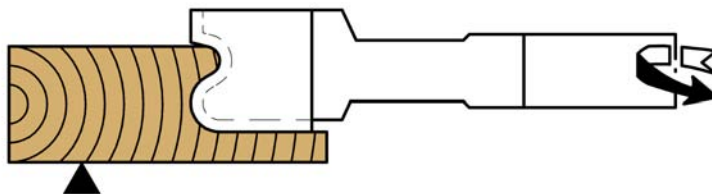

59FR
Fresas para plafones
Fraises plate bande

	Perfil/Profil	D	LC	d	Z	
F591BH	59/1	210	20	50	4	HSS
F592BH	59/2	210	20	50	4	HSS
F593BH	59/3	210	20	50	4	HSS
F594BH	59/4	210	20	50	4	HSS
F595BH	59/5	210	20	50	4	HSS
F596BH	59/6	210	20	50	4	HSS
F597BH	59/7	210	20	50	4	HSS
F598BH	59/8	210	20	50	4	HSS
F599BH	59/9	210	20	50	4	HSS
F591BM	59/1	210	20	50	4	MD / HM
F592BM	59/2	210	20	50	4	MD / HM
F593BM	59/3	210	20	50	4	MD / HM
F594BM	59/4	210	20	50	4	MD / HM
F595BM	59/5	210	20	50	4	MD / HM
F596BM	59/6	210	20	50	4	MD / HM
F597BM	59/7	210	20	50	4	MD / HM
F598BM	59/8	210	20	50	4	MD / HM
F599BM	59/9	210	20	50	4	MD / HM

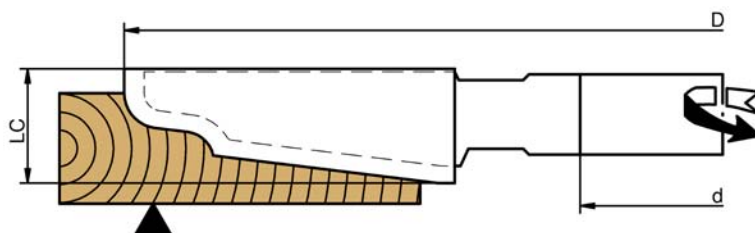

PERFILES NORMALIZADOS / PROFILS STANDARDS

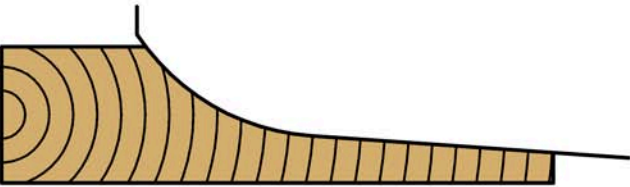

59/0

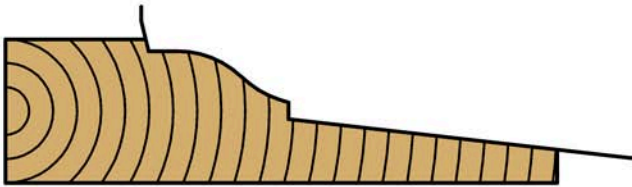

59/5

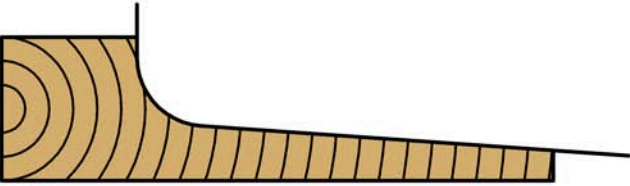

59/1

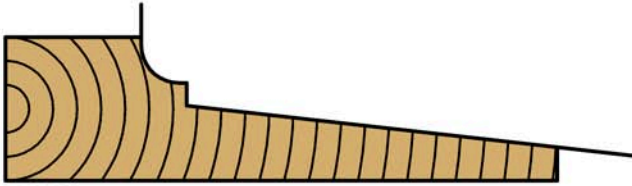

59/6

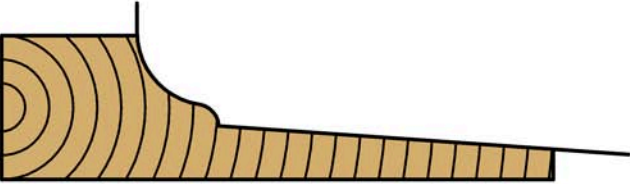

59/2

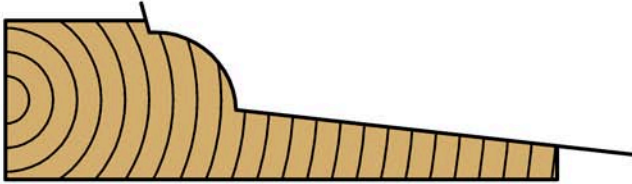

59/7

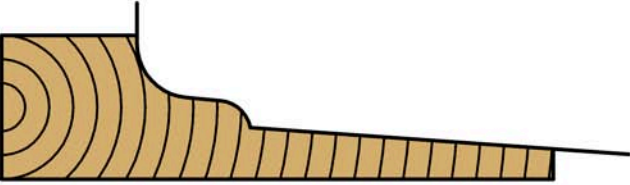

59/3

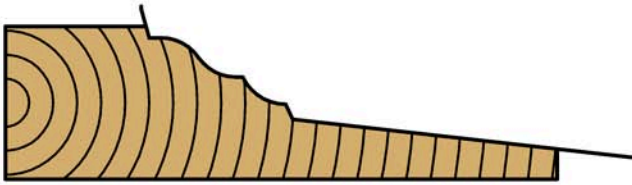

59/8

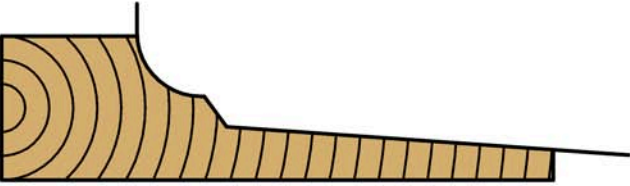

59/4

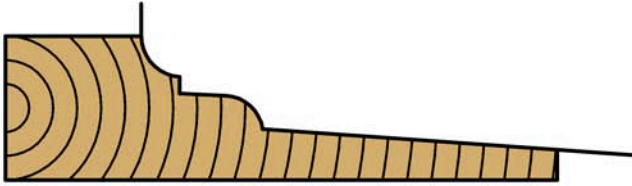

59/9

POSICION DE TRABAJO / POSITION DE TRAVAIL

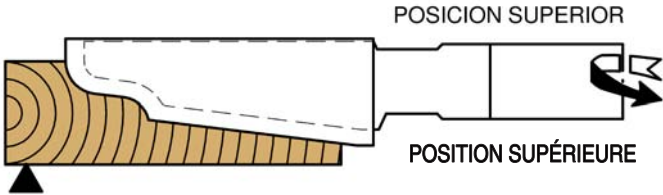

42FR

Fresas **MD** de radio
Fraises **HM** rayon

42/1	Ref.	R	D	LC	d	Z
F421AM	42/1	4	140	8	50	4
F421BM	42/1	5	140	10	50	4
F421CM	42/1	6	140	12	50	4
F421DM	42/1	8	140	16	50	4
F421EM	42/1	10	140	20	50	4
F421FM	42/1	12	140	24	50	4

42/2	Ref.	R	D	LC	d	Z
F422AM	42/2	10	140	15	50	4
F422BM	42/2	15	140	20	50	4
F422CM	42/2	20	140	25	50	4

42/3	Ref.	R	D	LC	d	Z
F423AM	42/3	5	140	15	50	4
F423BM	42/3	8	140	18	50	4
F423CM	42/3	10	140	20	50	4
F423DM	42/3	12	140	22	50	4
F423EM	42/3	15	140	25	50	4
F423FM	42/3	20	140	30	50	4

42/4	Ref.	R	D	LC	d	Z
F424AM	42/4	5	140	15	50	4
F424BM	42/4	8	140	18	50	4
F424CM	42/4	10	140	20	50	4
F424DM	42/4	12	140	22	50	4
F424EM	42/4	15	140	25	50	4
F424FM	42/4	20	140	30	50	4

42/5	Ref.	R	D	LC	d	Z
F425AM	42/5	4	140	18	50	4
F425BM	42/5	5	140	20	50	4
F425CM	42/5	6	140	22	50	4
F425DM	42/5	8	140	26	50	4
F425EM	42/5	10	140	30	50	4
F425FM	42/5	12	140	34	50	4

42/6	Ref.	R	D	LC	d	Z
F426AM	42/6	5	140	20	50	4
F426BM	42/6	6	140	22	50	4
F426CM	42/6	8	140	26	50	4
F426DM	42/6	10	140	30	50	4
F426EM	42/6	12	140	34	50	4

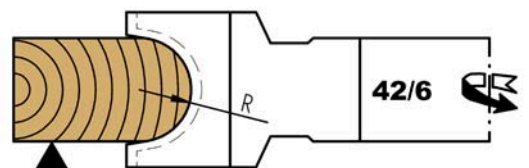
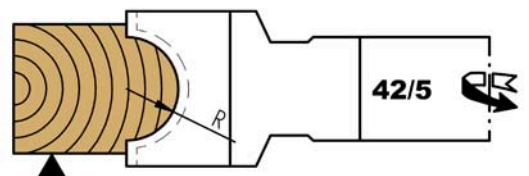
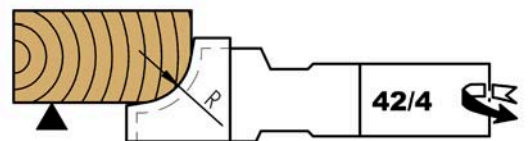
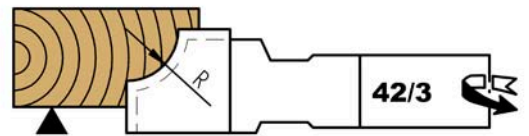
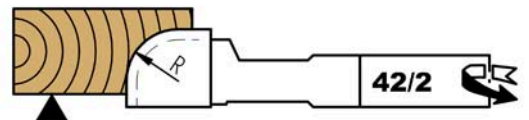
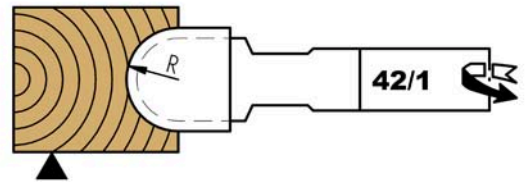

42FD

Fresas **PCD** Lamello
 Fraises **PCD** Lamello

	D	LC	d	Taladros Trous	Z
FD4222	100.4	7	22	4/4.2/36	3



91AC

Mandrilos porta-sierras/fresas
 Mandrin porte-lames/fraises

	d	D	LT	S	Taladros/Trous
A9122M20	22	50	90	Ø20x70	4/M4/36

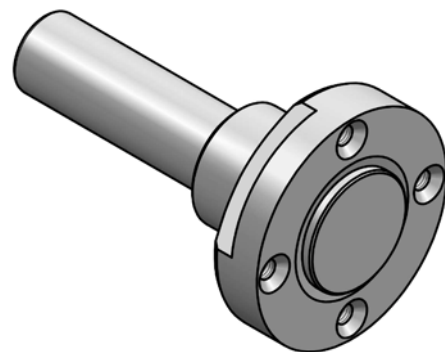
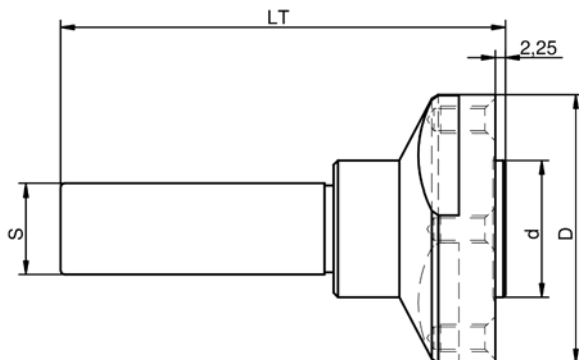

68CB
Cabezales cuchillas corrugadas, para diversos perfiles
Porte-outils à fers crantés, multi-profil

	D	LC	d	Z
C681BH	122	60	40	4
C681DH	122	100	40	4
C681EH	122	150	40	4
C682AH	137	60	50	4
C682CH	137	80	50	4
C682DH	137	100	50	4
C682EH	137	150	50	4

Precio del cuerpo sin cuchillas.
Prix du corp sans fers.

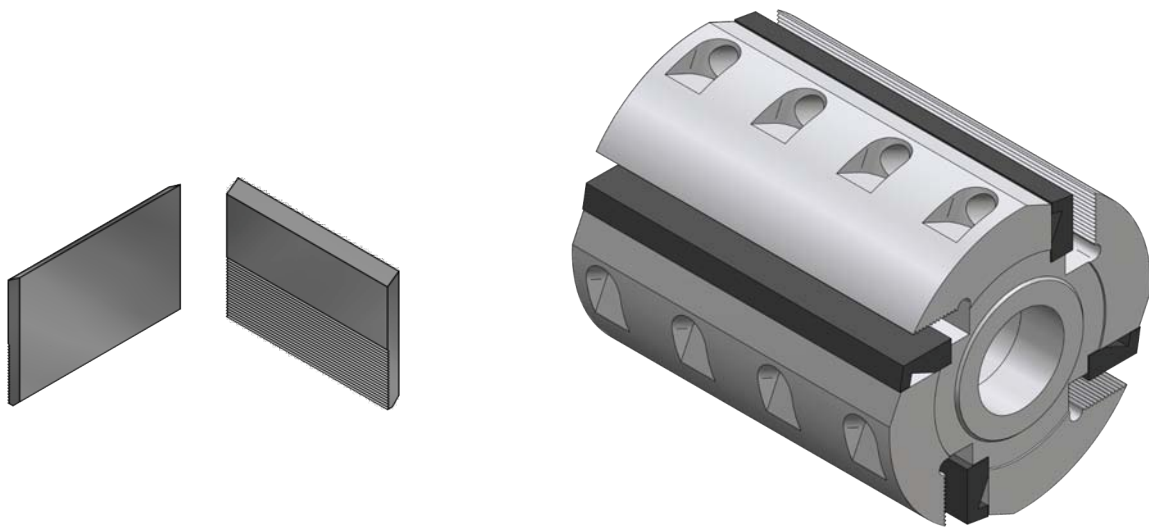
17CR
Cuchillas HSS corrugadas perfiladas
Fer cranté HSS profilé

ESPECIALES SPÉCIAUX		Ancho de corte / Longueur de coupe (LC)						
		40	50	60	80	100	120	150
Altura Hauteur (H)	50	17CR.101	17CR.102	17CR.103	17CR.104	17CR.105	17CR.106	17CR.107
	60	17CR.201	17CR.202	17CR.203	17CR.204	17CR.205	17CR.206	17CR.207
	70	17CR.301	17CR.302	17CR.303	17CR.304	17CR.305	17CR.306	17CR.307

Espesor (E) de 8 mm.
Epaisseur (E) de 8 mm.

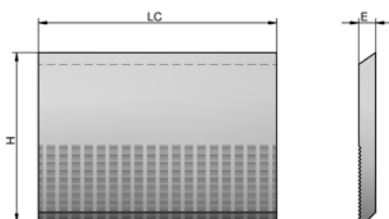

Altura Hauteur (H)	Altura máx. de perfil en HSS Hauteur máx. de profil en HSS
50	11 mm.
60	20 mm.
70	30 mm.

67CB

Cabezales de aluminio para diversos perfiles Porte-outils universel multi-profil

	D	LC	d	Z	Limitador Limiteur	Placas Plaquettes
C673AH	120	40	50	2	-	HSS
C674AH	120	40	50	2	2	HSS

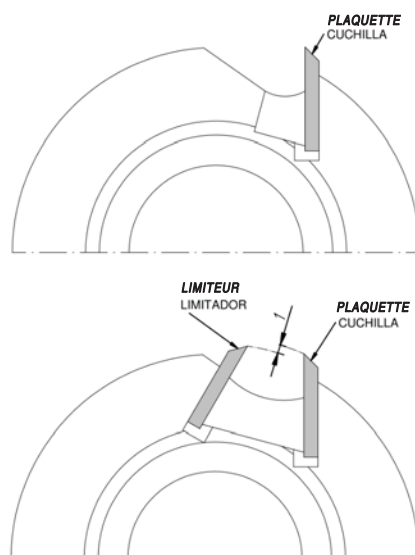
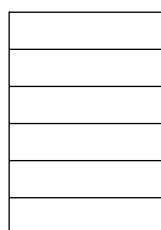
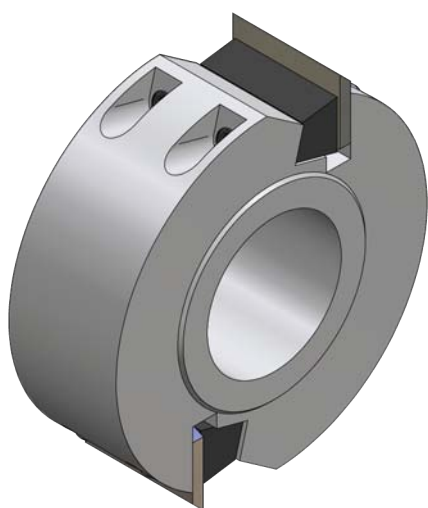

PERFILES ESTANDAR PROFILS STANDARDS		L	E	Perfil/Profil	Material Qualité
CU67H01..24	Cuchilla/Plaquette	40	4	67/01 a 67/24	HSS
CU32H01..67	Cuchilla/Plaquette	40	4	32/01 a 32/67	HSS
CL67H01..24	Limitador/Limiteur	40	4	67/01 a 67/24	-
CL32H01..67	Limitador/Limiteur	40	4	32/01 a 32/67	-

PERFILES ESPECIALES PROFILS SPÉCIAUX		L	E	H Max.	Material Qualité
67.001	Cuchilla/Plaquette	40	4	16 mm	HSS
67.002	Limitador/Limiteur	40	4	-	-
67.003	Cuchilla/Plaquette	50	4	18 mm	HSS
67.004	Limitador/Limiteur	50	4	-	-

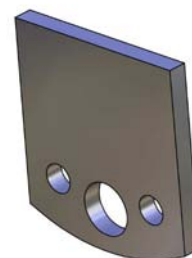
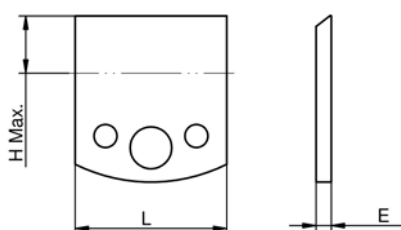

CUCHILLAS ESTANDAR / PLAQUETTES STANDARDS

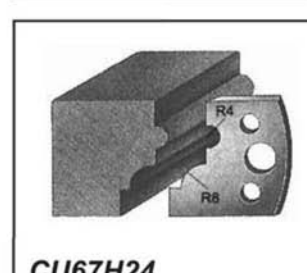
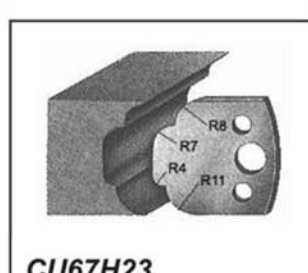
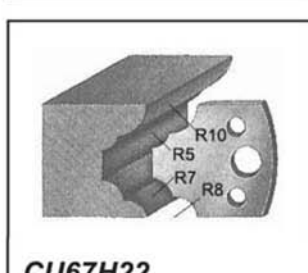
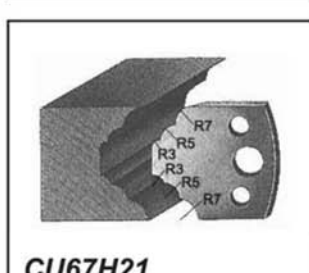
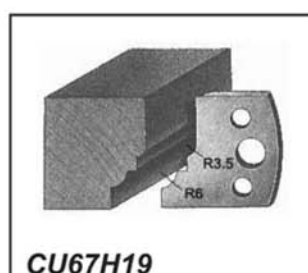
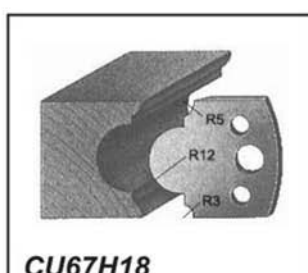
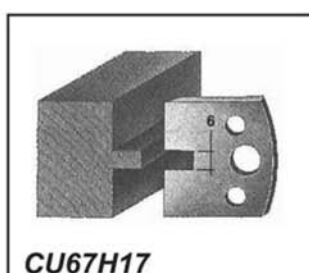
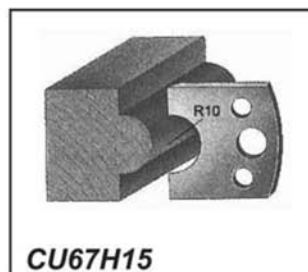
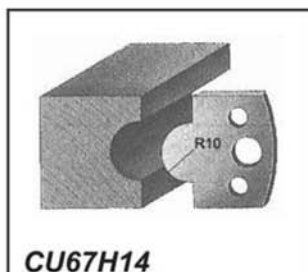
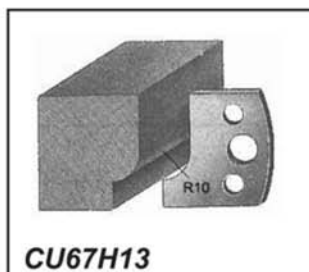
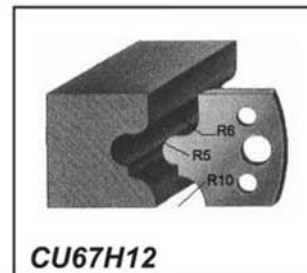
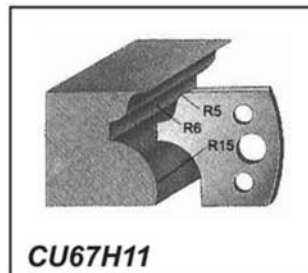
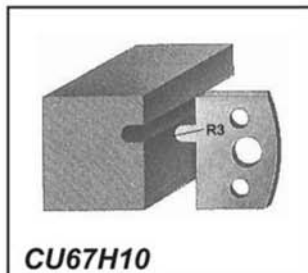
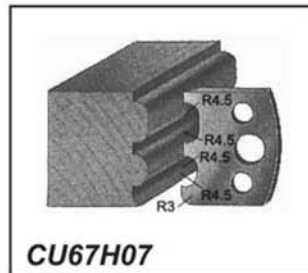
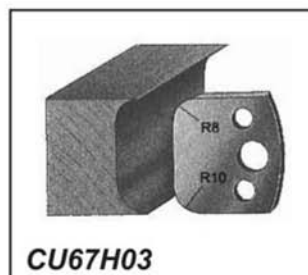
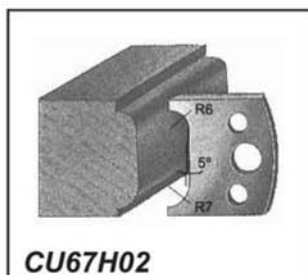
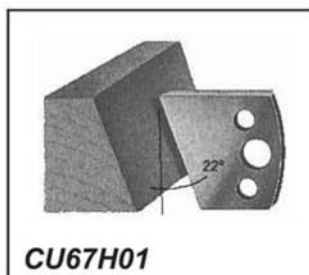

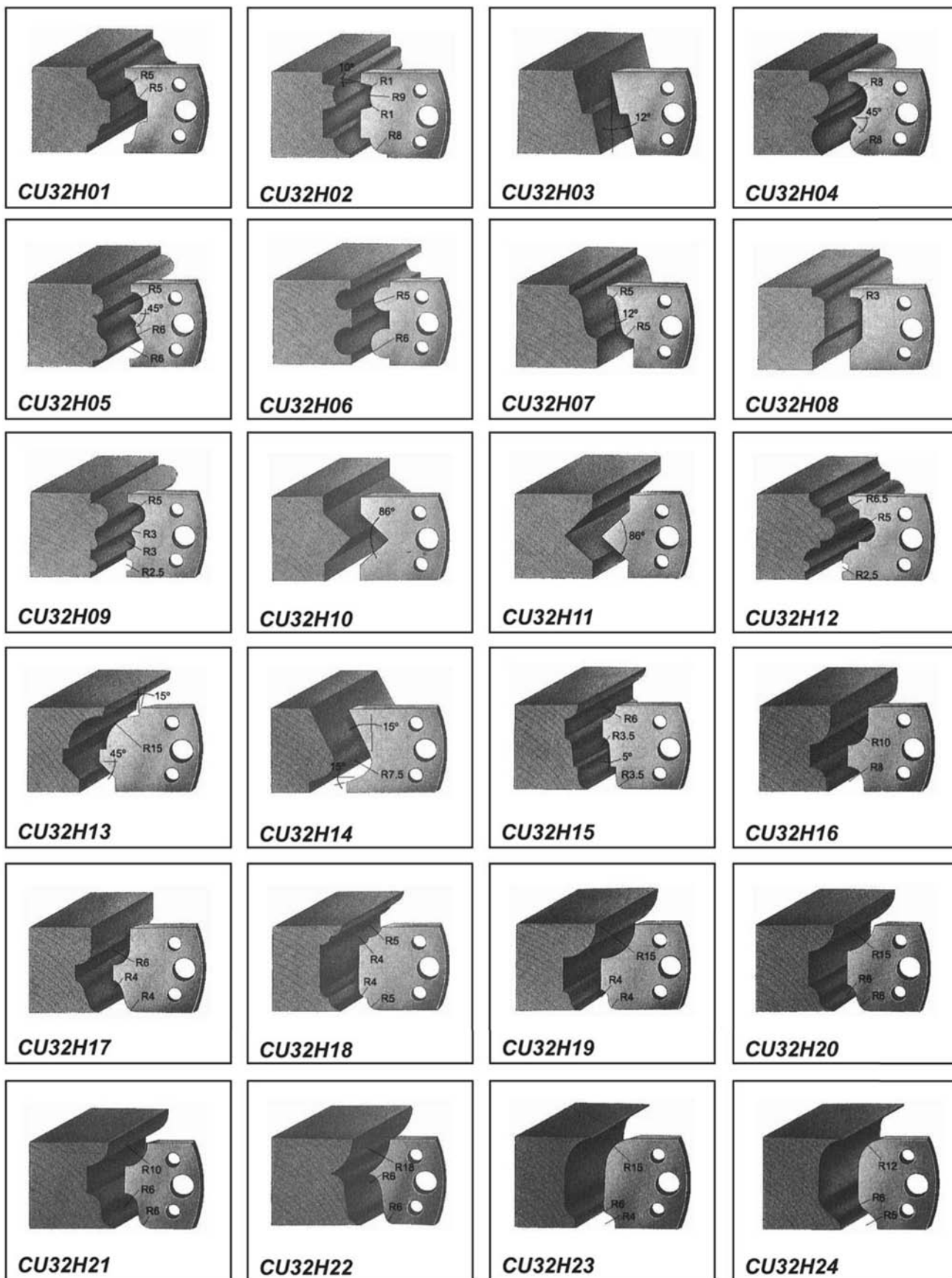

CUCHILLAS ESTANDAR / PLAQUETTES STANDARDS

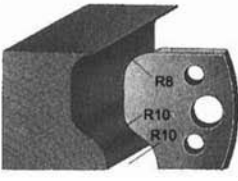
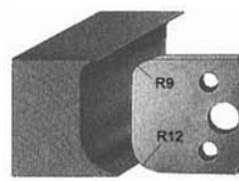
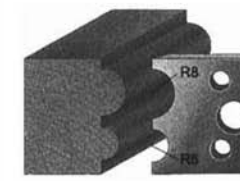
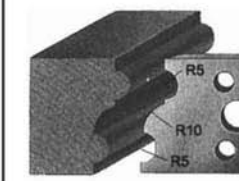
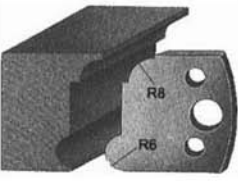
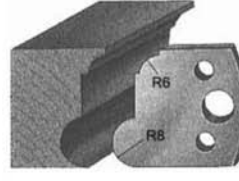
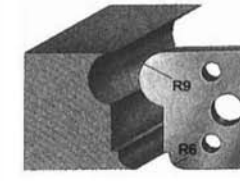
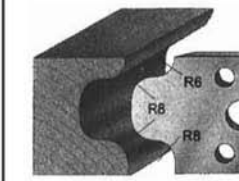
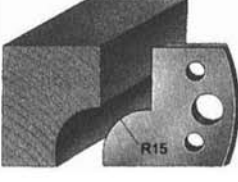
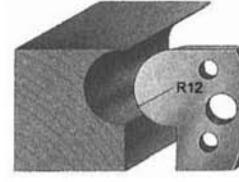
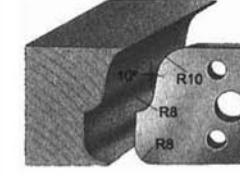
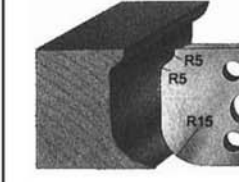
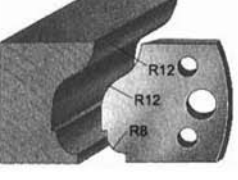
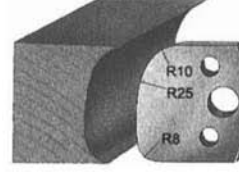
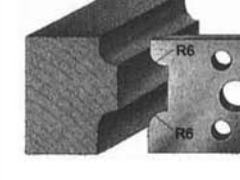
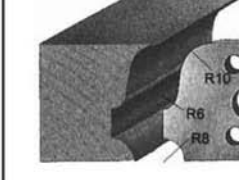
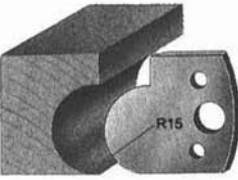
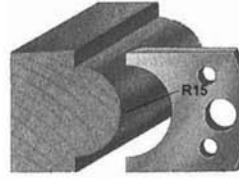
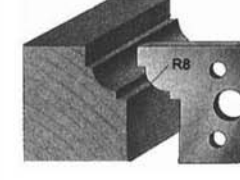
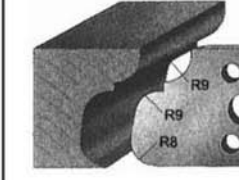
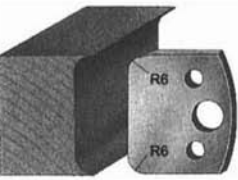
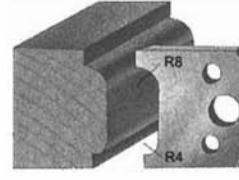
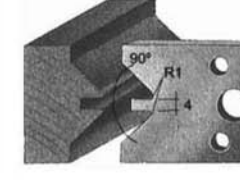
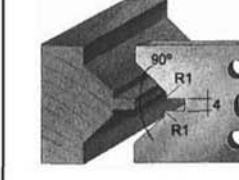
			
CU32H25	CU32H26	CU32H27	CU32H28
			
CU32H29	CU32H30	CU32H31	CU32H32
			
CU32H33	CU32H34	CU32H35	CU32H36
			
CU32H37	CU32H38	CU32H39	CU32H40
			
CU32H41	CU32H42	CU32H43	CU32H44
			
CU32H45	CU32H46	CU32H47	CU32H48

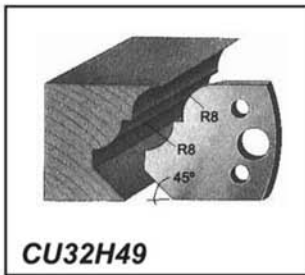

CU32H49



CU32H50

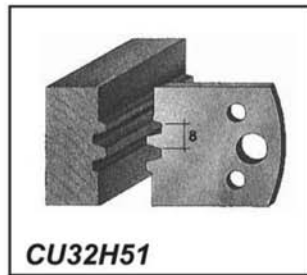

CU32H51

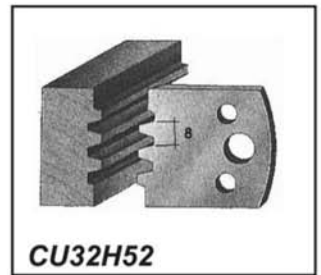

CU32H52

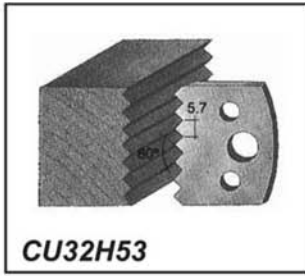

CU32H53

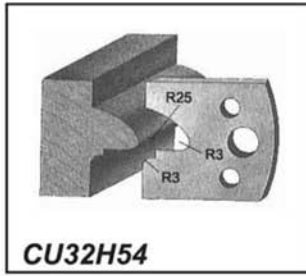

CU32H54

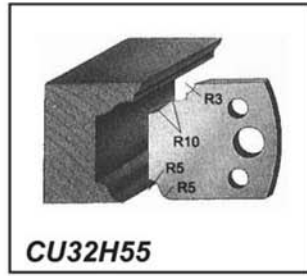

CU32H55

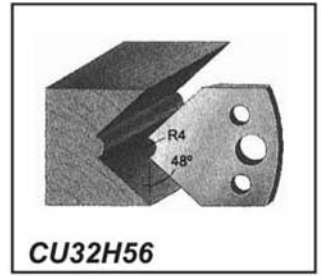

CU32H56

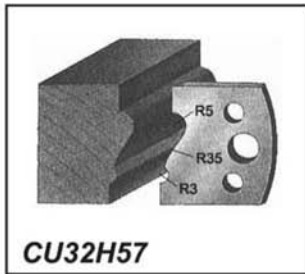

CU32H57

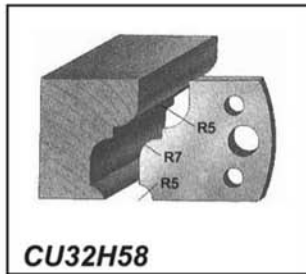

CU32H58

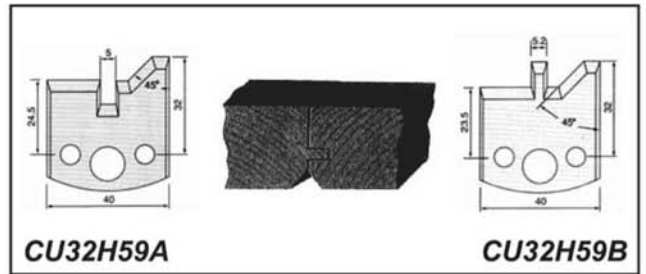

CU32H59A

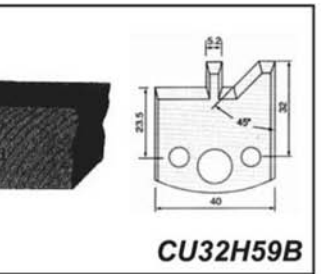

CU32H59B

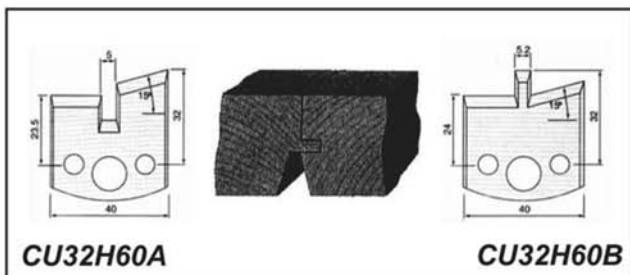

CU32H60A

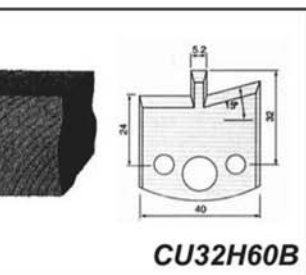

CU32H60B

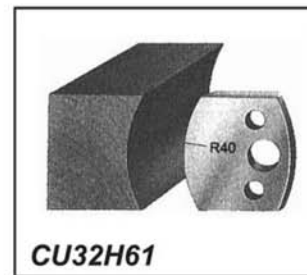

CU32H61



CU32H62

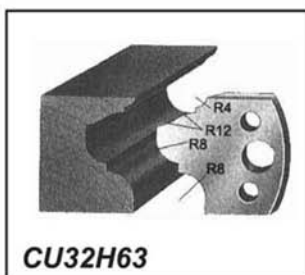

CU32H63

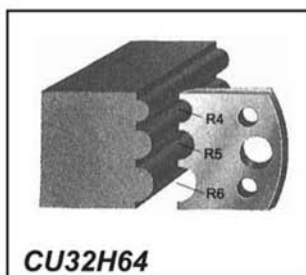

CU32H64

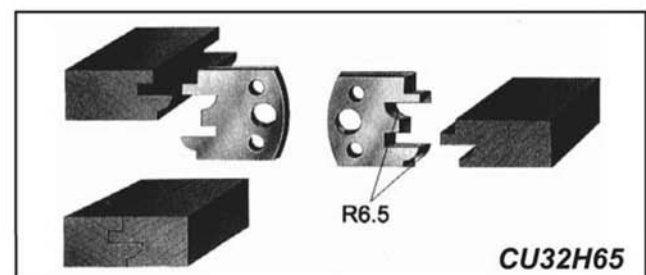

CU32H65

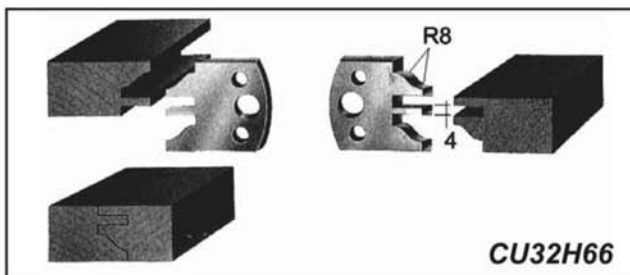

CU32H66



CU32H67A

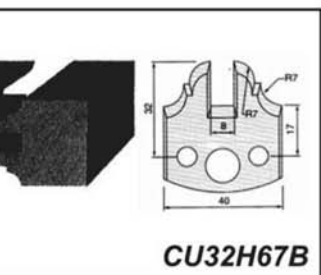

CU32H67B

79FR

Fresas **MD** perfiles normalizados de puertas
Fraises **HM** à profil et contre profil pour portes

	D	LC	d	Z	Prec. (V) Araseurs
79FRA	134	20	50	4	-
79FRB	140	20	50	4	-
79FRC	140	8/15.5	50	2+2	2+2
79FRD	140	20	50	4	-
79FRE	300	20	50	3	3
79FRF	300	20	50	3	3
79FRG	270	8/15.5	50	2+2	2+2
79FRH	140	50	50	4	2+2
79FRI	270	30	50	3	3
79FRJ	270	8	50	3	3+3
79FRK	300	12.5/24	50	2+2	2+2

Indicar el perfil a fabricar
Indiquer le profil a fabriquer

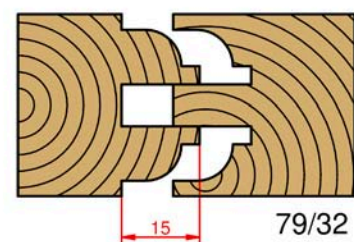
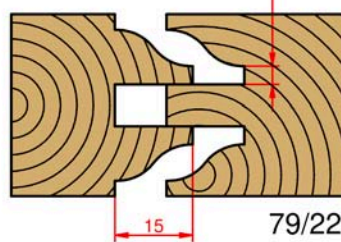
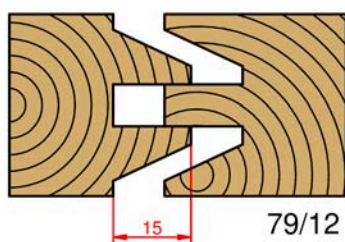
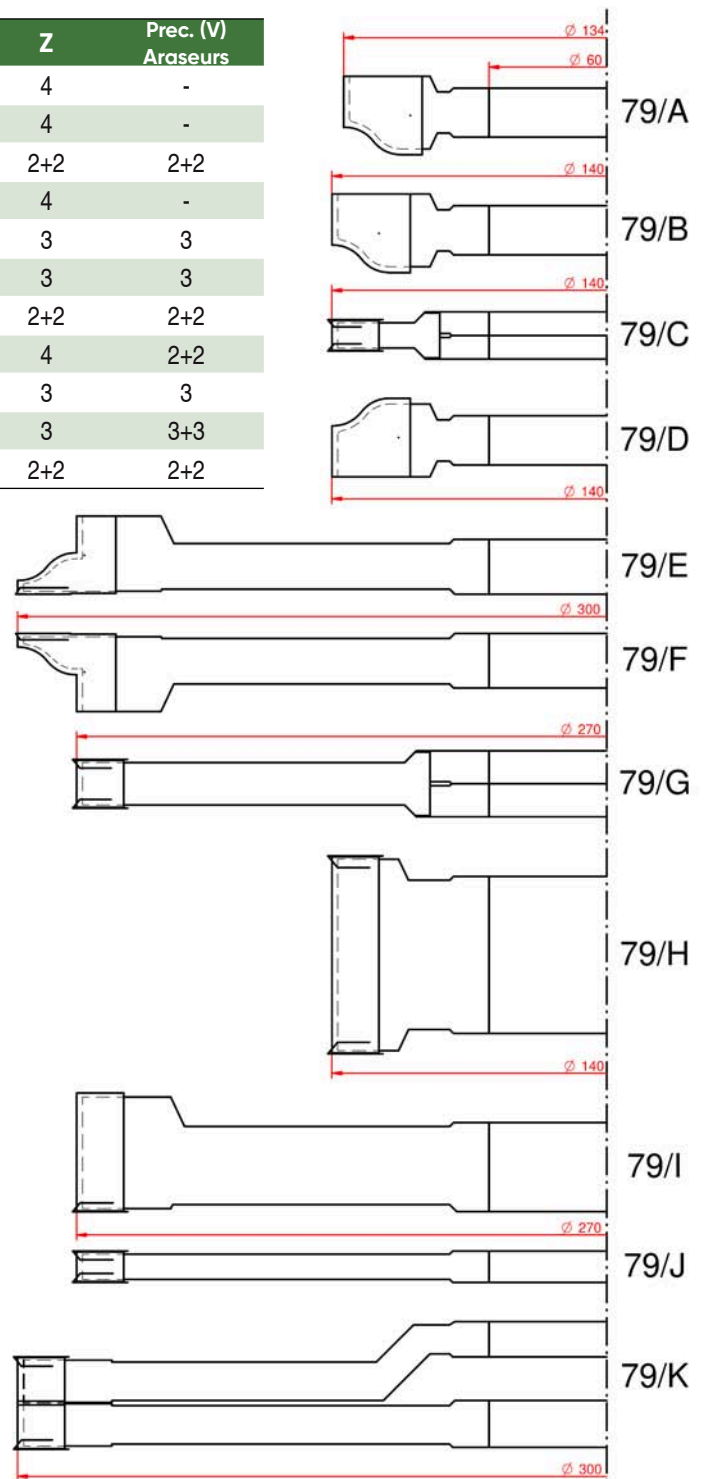

TIPOS DE TRABAJO TYPES DE TRAVAIL

PUERTA DE PASO MADERA: 35/45 mm
PORTE DE PASSAGE EN BOIS: 35/45 mm

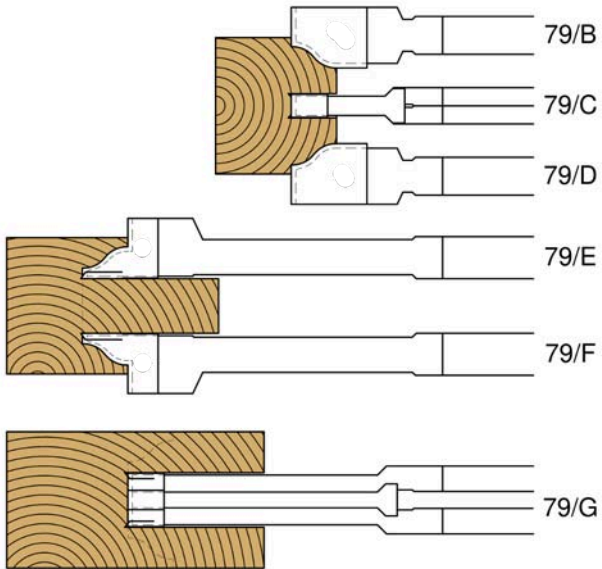

PUERTA CRISTALERA MADERA: 35/45 mm
PORTE VITRÉE EN BOIS: 35/45 mm

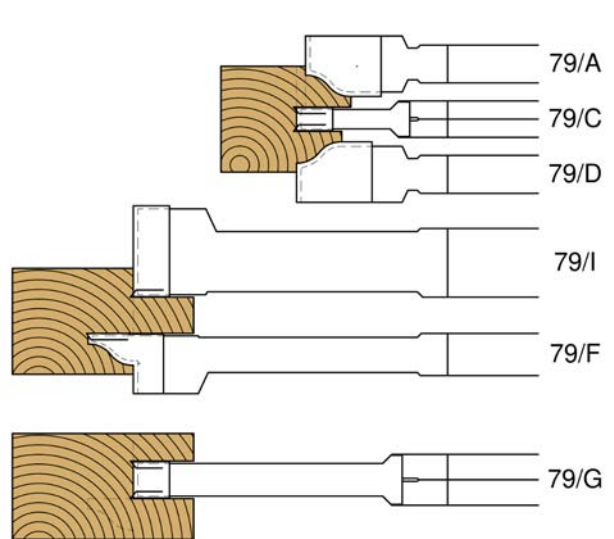

MARCO DE PUERTA MADERA: 60/70/90 mm
CADRE DE PORTE EN BOIS: 60/70/90 mm

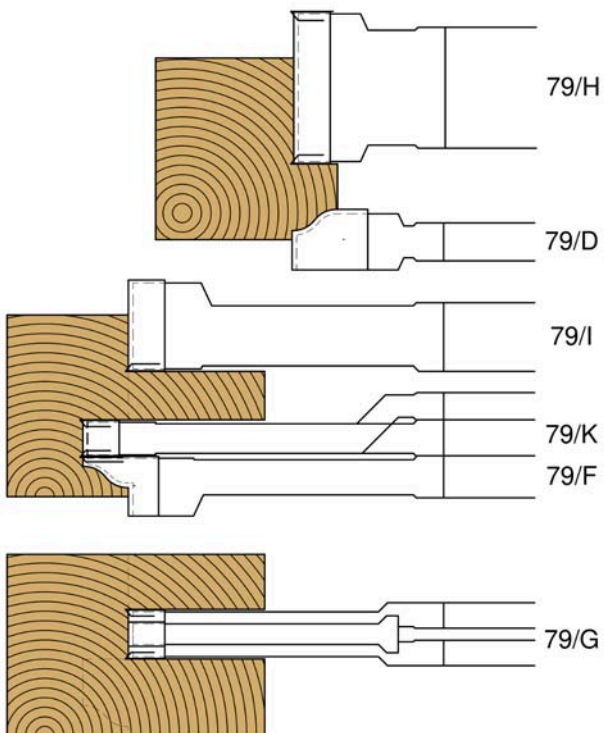

HOJA DE VENTANA MADERA: 54/60 mm
CHÂSSIS DE FÊNETRE EN BOIS: 54/60 mm

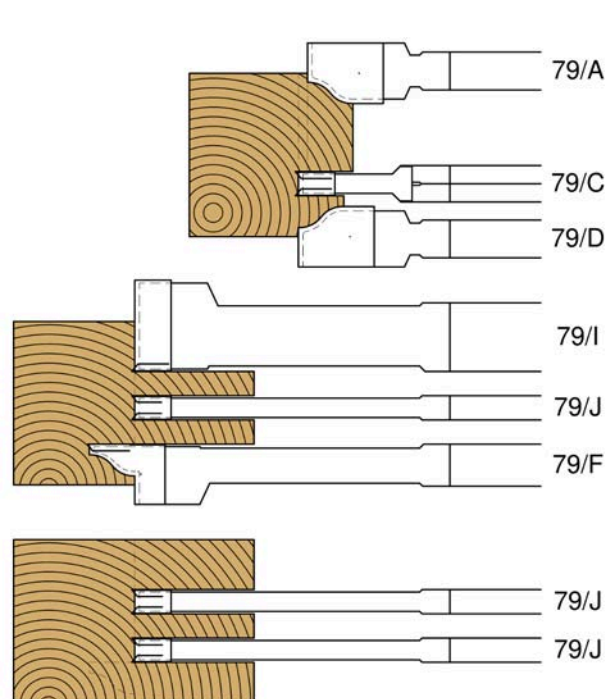

94CB

Cabezales **MD** perfiles normalizados de puertas
 Porte-outils **HM** à profil et contre profil pour portes

	D	LC	d	Z	Prec. (V)	Placas
94CBA	154	20	60	3	-	2 mm.
94CBB	160	20	60	3	-	2 mm.
94CBC	160	8/15.5	60	2+2	2+2	1.5 mm.
94CBD	160	20	60	3	-	2 mm.
94CBE	298	20	60	3	3	2 mm.
94CBF	298	20	60	3	3	2 mm.
94CBG	268	8/15.5	60	2+2	2+2	1.5 mm.
94CBH	160	50	60	3	3+3	1.5 mm.
94CBI	268	30	60	3	3	1.5 mm.
94CBJ	268	8	60	3	3+3	1.5 mm.
94CBK	298	12.5/24	60	2+2	2+2	1.5 mm.

Se debe indicar el perfil a fabricar
 Faut indiquer le profil à fabriquer

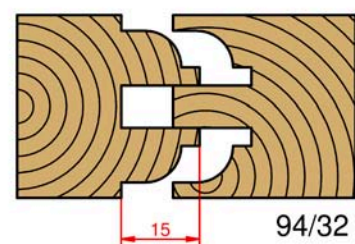
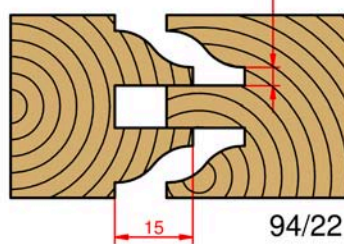
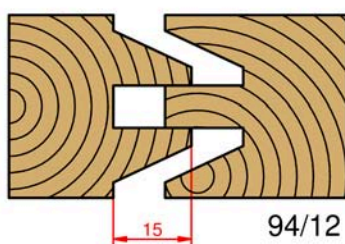
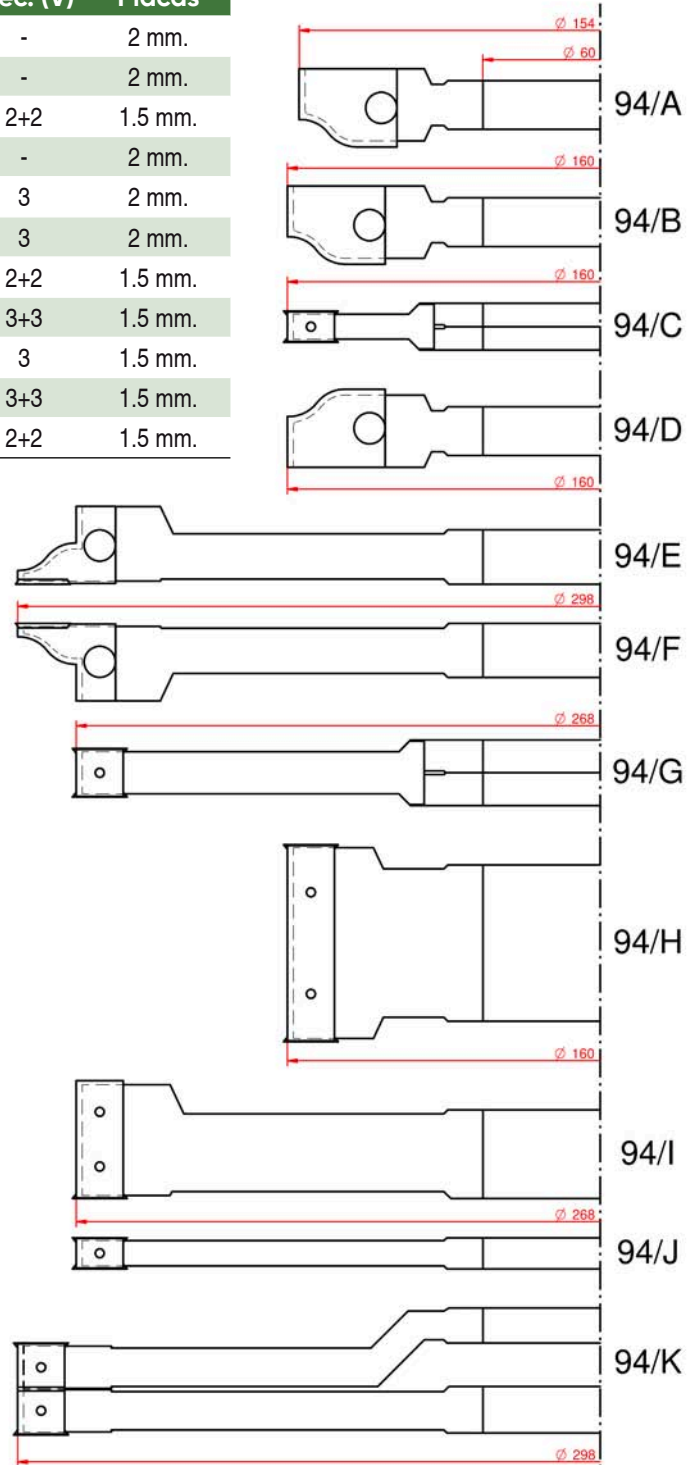

TIPOS DE TRABAJO TYPES DE TRAVAIL

PUERTA DE PASO MADERA: 35/45 mm
PORTE DE PASSAGE EN BOIS: 35/45 mm

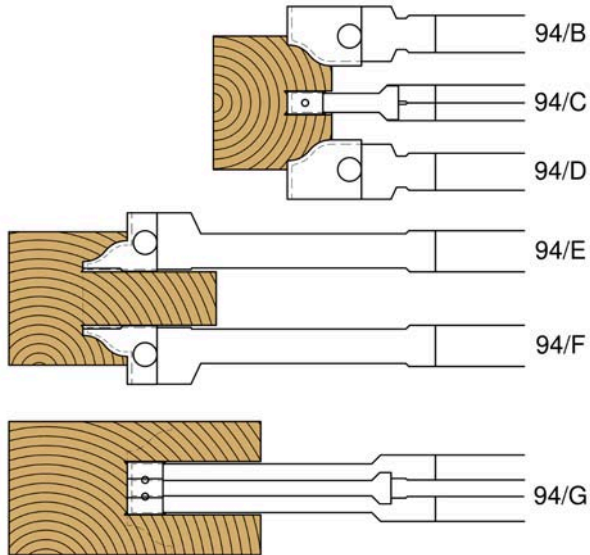

PUERTA CRISTALERA MADERA: 35/45 mm
PORTE VITRÉE EN BOIS: 35/45 mm

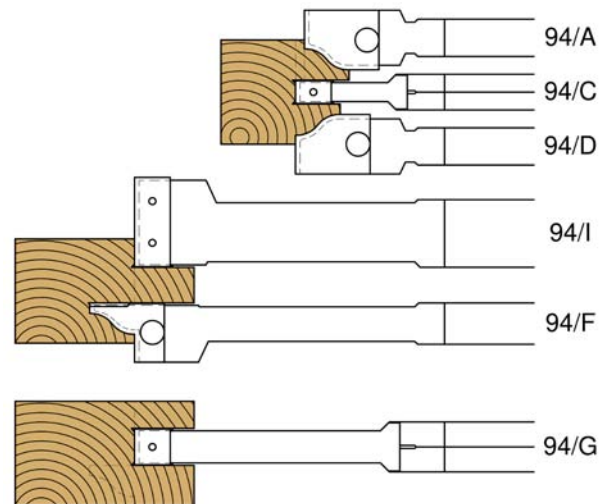

MARCO DE PUERTA MADERA: 60/70/90 mm
CADRE DE PORTE EN BOIS: 60/70/90 mm

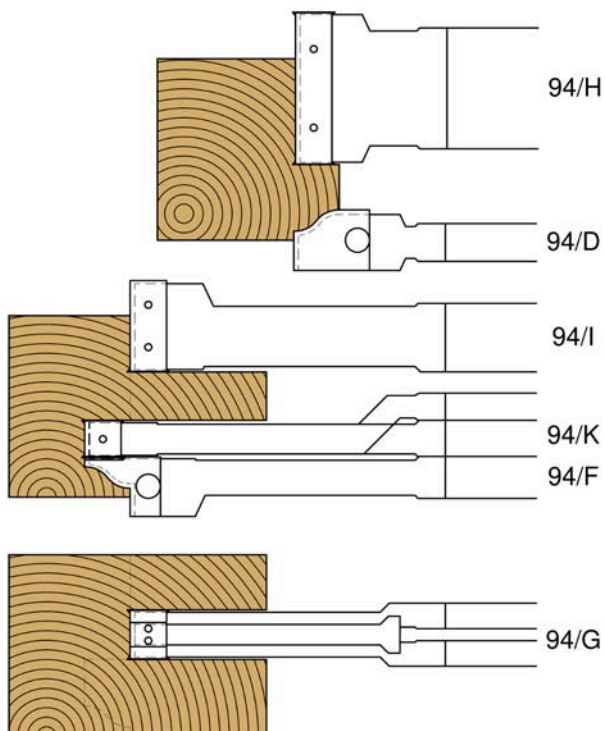

HOJA DE VENTANA MADERA: 54/60 mm
CHÂSSIS DE FÊNETRE EN BOIS: 54/60 mm

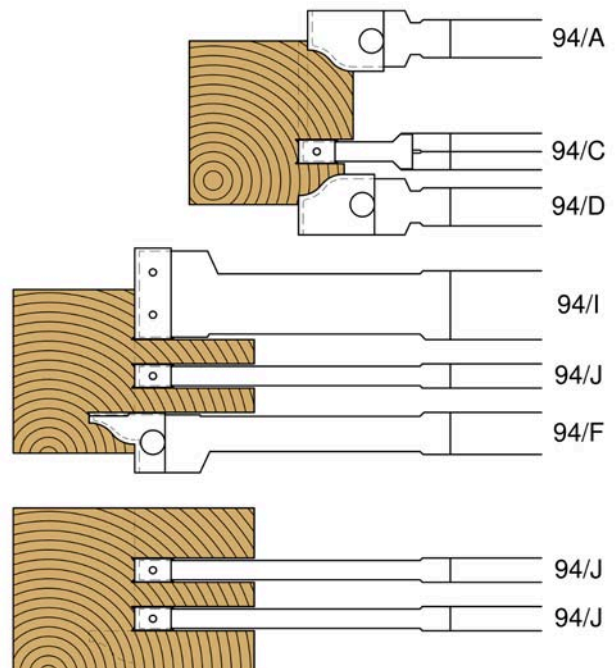

06FR

Fresas **MD** rectas retestado de aluminio
Fraises **HM** droites pour aluminium

	D	LC	d	Z
F07005	70	5	32	8
F07006	70	6	32	8
F07008	70	8	32	8
F07105	71	5	32	8
F07204	72	4	32	8
F07205	72	5	32	8
F07206	72	6	32	8
F07207	72	7	32	8
F07208	72	8	32	8
F07405	74	5	32	8
F07406	74	6	32	8
F07505	75	5	32	8
F07506	75	6	32	8
F07605	76	5	32	8
F07606	76	6	32	8
F07607	76	7	32	8
F10005	100	5	32	10
F10006	100	6	32	10
F10008	100	8	32	10
F11005	110	5	32	12
F11006	110	6	32	12
F11205	112	5	32	12
F11206	112	6	32	12
F11405	114	5	32	12
F11406	114	6	32	12
F11408	114	8	32	12
F11606	116	6	32	12

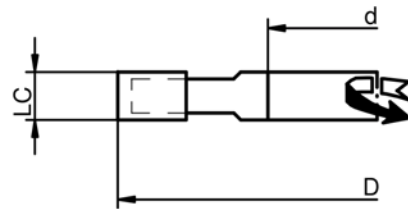

ESPECIALES MD SPÉCIALES HM		ANCHO DE CORTE / LARGUEUR DE COUPE (LC)				
		Hasta/Jusq'a 5	6 - 10	11 - 15	16 - 20	21 - 25
DIAM. (D)	Hasta/Jusq'a 90 Z8	06FR.101	06FR.102	06FR.103	06FR.104	06FR.105
	91 - 100 Z10	06FR.201	06FR.202	06FR.203	06FR.204	06FR.205
	101 - 120 Z12	06FR.301	06FR.302	06FR.303	06FR.304	06FR.305
	121 - 135 Z14	06FR.401	06FR.402	06FR.403	06FR.404	06FR.405
	136 - 160 Z16	06FR.501	06FR.502	06FR.503	06FR.504	06FR.505

25AC

Anillos de separación Bagues de séparation

	D	L	d
A25JK10	45	1	32
A25JK15	45	1.5	32
A25JK20	45	2	32
A25JK25	38	2.5	32
A25JK30	38	3	32
A25JK35	38	3.5	32
A25JK40	38	4	32
A25JK45	38	4.5	32
A25JK50	38	5	32
A25JK60	38	6	32
A25JK80	38	8	32
A25JK100	38	10	32
A25JK110	38	11	32
A25JK115	38	11.5	32

	D	L	d
A25JK120	38	12	32
A25JK125	38	12.5	32
A25JK130	38	13	32
A25JK135	38	13.5	32
A25JK150	38	15	32
A25JK190	38	19	32
A25JK230	38	23	32
A25JK250	38	25	32
A25JK300	38	30	32
A25JK350	38	35	32
A25JK400	38	40	32
A25JK500	38	50	32
A25JK600	38	60	32

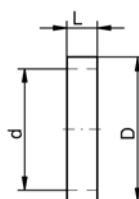

80AC

Casquillos portafresas Arbre porte-outils

	Máquina / Machine	Medidas / Dimensions
A80C02	Tipo general / Type général	d22 x D32 x 80
A80C03	Tipo general / Type général	d27 x D32 x 80
A80C04	Tipo general / Type général	d27 x D32 x 110
A80C05	Rinaldi 10B / Pertici ML120 / 3C 2500	d27 x D32 x 100
A80C06	Rinaldi 9A / Omga AL132 / Pertici ML124	d27 x D32 x 135
A80C07	Giovannini Work / 3C 3000 (Rot. Dx.)	d27 x D32 x 135
A80C08	Rinaldi 350 DS / 3C 3500	d27 x D32 x 160
A80C09	Mecal 706 - 702 - 703	d27 x D32 x 150
A80C15	FOM jet / Mistral / Marak	d25 x D32 x 168
A80C20	Omc Feroce	d27 x D32 x 134
A80C22	Mcód. I 711	d25 x D32 x 162
A80C23	Tronzonage MG / Rafre	d27 x D32 x 142
A80C24	Ayutor	d21 x D32 x 95
A80C25	Tekna TK610	d27 x D32 x 140

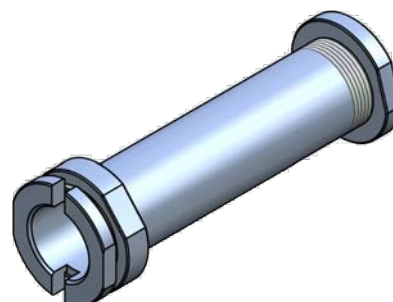
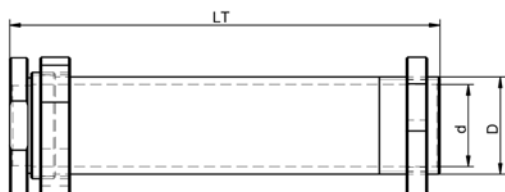

10CR1

Cuchillas **MD** reversibles
Plaquettes **HM** réversibles

	L	H	E	
CU101B1	7.5	12	1.5	
CU101C1	9.6	12	1.5	
CU101D1	12	12	1.5	Z4
CU101F1	20	12	1.5	
CU101FG1	25	12	1.5	1 Agujero/Trou
CU101FG2	25	12	1.5	2 Agujeros/Trous
CU101G1	30	12	1.5	
CU101H1	40	12	1.5	
CU101I1	50	12	1.5	
CU101J1	60	12	1.5	
CU101K1	80	13	2.2	
CU101L1	100	13	2.2	
CU10ZD1	29.5	12	1.5	Z4
CU10ZF1	49.5	12	1.5	Z4
CU103FG3	24.7	12	1.5	4 Biseles/Biseaux
CU103FG4	30	12	1.5	4 Biseles/Biseaux

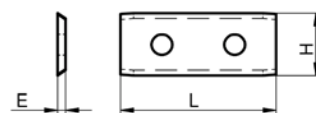
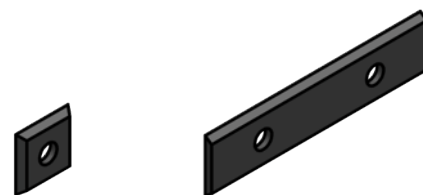
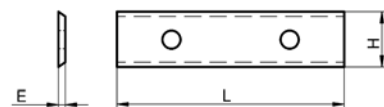

10CR2

Precortadores **MD**
Araseurs **HM**

	L	H	E	
CU102C0	14	14	1.2	
CU102C1	14	14	2.0	
CU102F1	15	15	2.5	Guillen (R150)
CU102D1	17	17	2.0	
CU102T1	21.9	19	2.0	Triang.

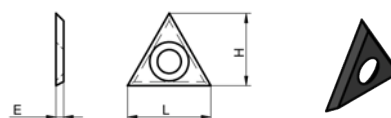
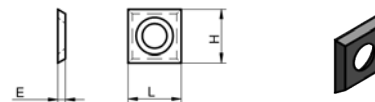

10CR3

Cuchillas **MD** para ranurar
Plaquettes **HM** à rainer

	L	H	E
CU103A1	18	18	1.95
CU103B1	18	18	2.95
CU103C1	18	18	2.5
CU103D1	18	18	3.7

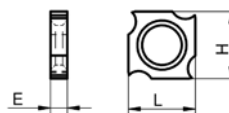

10CR4**Cuchillas MD para cajeados**
Plaquettes HM logement de serrures

	L	H	E	
CUR1A16	16	7	1.5	1 Ranura/Rainure
CUR2B16	16	7	1.5	2 Ranuras/Rainures
CUR2A23	23	7	1.5	2 Ranuras/Rainures
CUR3B23	23	7	1.5	3 Ranuras/Rainures
CUR2A28	28	7	1.5	2 Ranuras/Rainures
CUR2B28	28	7	1.5	2 Ranuras/Rainures

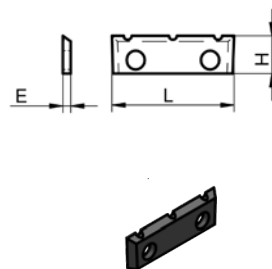
**12CR****Cuchillas para cepillar**
Fers de rabotage

	L	H	E	
CU12H120C	120	30	3	HSS
CU12H130C	130	30	3	HSS
CU12H150C	150	30	3	HSS
CU12H160C	160	30	3	HSS
CU12H180C	180	30	3	HSS
CU12H200C	200	30	3	HSS
CU12H210C	210	30	3	HSS
CU12H230C	230	30	3	HSS
CU12H240C	240	30	3	HSS
CU12H300C	300	30	3	HSS
CU12H350C	350	30	3	HSS
CU12H400C	400	30	3	HSS
CU12H410C	410	30	3	HSS
CU12H450C	450	30	3	HSS
CU12H500C	500	30	3	HSS
CU12H600C	600	30	3	HSS

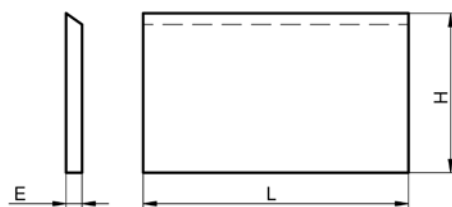

20CR

Cuchillas reversibles **MD**
Plaquettes réversibles **HM**

	L	H	E	
CU202055T	20	5.5	1.1	Titanio
CU202010T	20	10	1.5	Titanio
CU203010T	30	10	1.5	Titanio



21CR

Cuchillas rev. **MD** para cepillos electroportátiles
Plaquettes réversibles **HM** pour rabot electroportatif

	L	H	E	
CU21CM	82	5.5	1.1	
CU21FM	78	5.5	1.1	

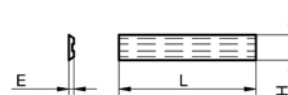

22CR

Cuchillas para cepillos electroportátiles
Plaquettes pour rabot electroportatif

	L	H	E		
CU22HB	82	29	3	HSS	Makita
CU22MB	82	29	3	MD/HM	Makita

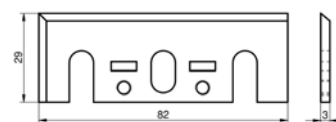

25CR

Cuchillas tipo **CENTROLOCK HSS**
Fers de rabotage **CENTROLOCK HSS**

	L	H	E	
CU12C130H	130	16	3	
CU12C160H	160	16	3	
CU12C180H	180	16	3	
CU12C210H	210	16	3	
CU12C230H	230	16	3	

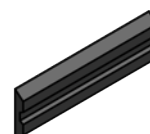
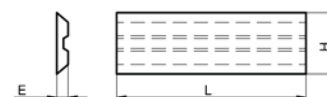

26CR
Cuchillas tipo TERSA HSS
Fers de rabotage TERSA HSS

	L	H	E	
HS100	100	10	2.3	HSS
HS110	110	10	2.3	HSS
HS120	120	10	2.3	HSS
HS130	130	10	2.3	HSS
HS150	150	10	2.3	HSS
HS180	180	10	2.3	HSS
HS200	200	10	2.3	HSS
HS210	210	10	2.3	HSS
HS230	230	10	2.3	HSS
HS250	250	10	2.3	HSS
HS260	260	10	2.3	HSS
HS300	300	10	2.3	HSS
HS350	350	10	2.3	HSS
HS400	400	10	2.3	HSS
HS410	410	10	2.3	HSS
HS450	450	10	2.3	HSS
HS500	500	10	2.3	HSS
HS510	510	10	2.3	HSS
HS520	520	10	2.3	HSS
HS530	530	10	2.3	HSS
HS550	550	10	2.3	HSS
HS600	600	10	2.3	HSS
HS630	630	10	2.3	HSS
HS640	640	10	2.3	HSS
HS650	650	10	2.3	HSS

M42	L	H	E	
T1100	100	10	2.3	HSS M42
T1110	110	10	2.3	HSS M42
T1120	120	10	2.3	HSS M42
T1130	130	10	2.3	HSS M42
T1150	150	10	2.3	HSS M42
T1180	180	10	2.3	HSS M42
T1200	200	10	2.3	HSS M42
T1210	210	10	2.3	HSS M42
T1230	230	10	2.3	HSS M42
T1250	250	10	2.3	HSS M42
T1260	260	10	2.3	HSS M42
T1300	300	10	2.3	HSS M42
T1350	350	10	2.3	HSS M42
T1400	400	10	2.3	HSS M42
T1410	410	10	2.3	HSS M42
T1450	450	10	2.3	HSS M42
T1500	500	10	2.3	HSS M42
T1510	510	10	2.3	HSS M42
T1520	520	10	2.3	HSS M42
T1530	530	10	2.3	HSS M42
T1550	550	10	2.3	HSS M42
T1600	600	10	2.3	HSS M42
T1630	630	10	2.3	HSS M42
T1640	640	10	2.3	HSS M42
T1650	650	10	2.3	HSS M42

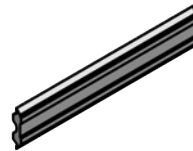
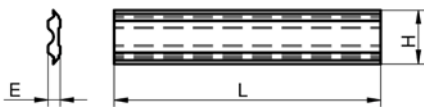

31CR

Ranuradores, chaflanadores y redondeadores **MD**
 Plaquettes **HM** à rainer, chanfreiner et arrondir

	L	H	E	
CU311AM	16	22	5	Chaflán/Chanfrein 45°
CU312DM	16	22	5	R 1.5
CU312CM	16	22	5	R 3
CU313KM	16	34	3	Ranura/Rainure 3 mm
CU313IM	16	34	4	Ranura/Rainure 4 mm
CU313JM	16	34	5	Ranura/Rainure 5 mm

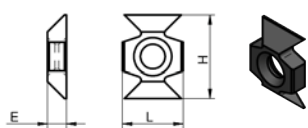

Chaflanador
Chanfreiner

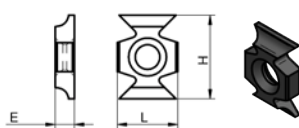

Redondeador
Arrondir

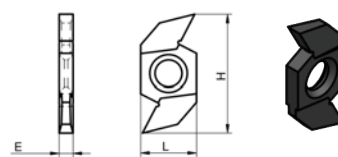

Ranurador
Rainer

GUBIAS

Cuchillas **HSS** para torno

GOUGES

Plaquettes **HSS** pour tournage

	E	H	L	
GU1P16H	16	16	150	1 Punta/Pointe
GU1P20H	20	20	200	1 Punta/Pointe
GU3P16H	16	16	150	1 Punta/Pointe + Cuña/Coin
GU3P20H	20	20	200	1 Punta/Pointe + Cuña/Coin



1 Punta

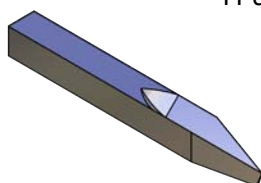

1 Pointe

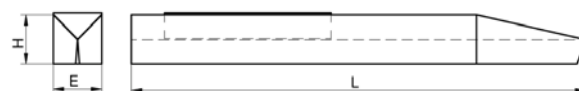

1 Punta + Cuña

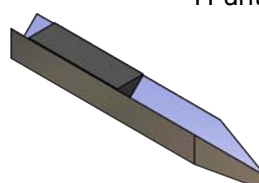

1 Pointe + Coin de serrage

86AC

**Portapinzas / Porta-herramientas
Mandrin / Arbres porte-outils**

	Descripción / Description	Tipo/Type
A86204	Portapinzas/Mandrin HSK63F ER32	86/1
A86222	Portapinzas/Mandrin HSK63F ER40	86/2
A86226	Portapinzas/Mandrin HSK63F ORT25A	86/3

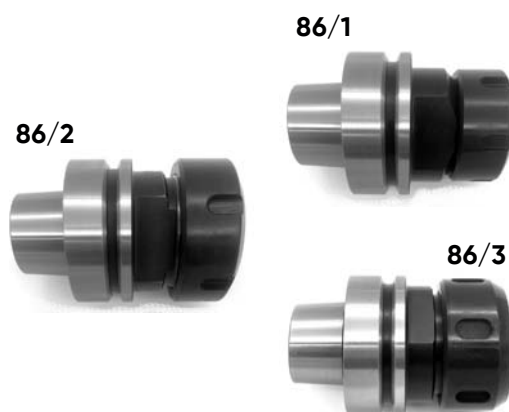

	Descripción / Description	Tipo/Type
A86502	Portapinzas/Mandrin ISO30 ER32 "Biesse"	86/5



	Descripción / Description	Tipo/Type
A86244	Porta-herramientas/Arbre porte-outils HSK63F Eje/Alésage: D30 x L100	86/8
A86249	Porta-herramientas/Arbre porte-outils HSK63F Eje/Alésage: D30 x L160	86/8

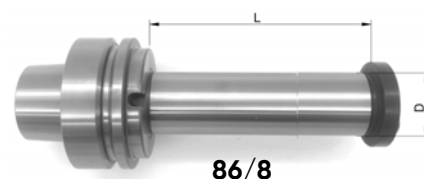

	Descripción / Description	Tipo/Type
A86HG12	Porta-htas./Porte-out. HYDRO GRIP HSK63F Ø12	86/10
A86HG16	Porta-htas./Porte-out. HYDRO GRIP HSK63F Ø16	86/10
A86HG20	Porta-htas./Porte-out. HYDRO GRIP HSK63F Ø20	86/10



	Descripción / Description	Tipo/Type
A8614012TI	Porta-htas. Térmico/Cône thermique HSK63F D12	86/11
A8614016TI	Porta-htas. Térmico/Cône thermique HSK63F D16	86/11
A8614020TI	Porta-htas. Térmico/Cône thermique HSK63F D20	86/11

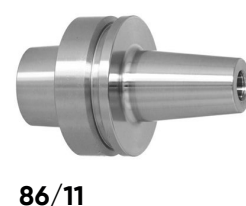

87AC

Pinzas Pinces

ER32	D	d	L
A8713203	33	3 - 2	40
A8713204	33	4 - 3	40
A8713206	33	6 - 5	40
A8713208	33	8 - 7	40
A8713210	33	10 - 9	40
A8713212	33	12 - 11	40
A8713214	33	14 - 13	40
A8713216	33	16 - 15	40
A8713220	33	20 - 19	40

ER40	D	d	L
A8714006	41	6 - 5	46
A8714008	41	8 - 7	46
A8714010	41	10 - 9	46
A8714012	41	12 - 11	46
A8714016	41	16 - 15	46
A8714020	41	20 - 19	46
A8714025	41	25 - 24	46

ORT25	D	d	L
A8722503	35.5	3	52
A8722506	35.5	6	52
A8722508	35.5	8	52
A8722510	35.5	10	52
A8722512	35.5	12	52
A8722516	35.5	16	52
A8722520	35.5	20	52
A8722525	35.5	25	52

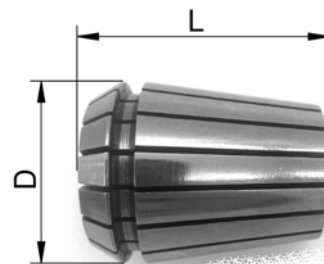

PINZAS/PINCES ER

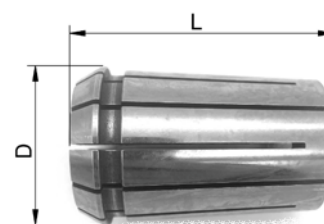

PINZAS/PINCES ORT

91AC

Mandrilos portasierras Mandrin porte-lames

	d	D	LT	S	Taladros/Trous
A9120M20	20	49	80	Ø20x60	4/M5/32
A9122M20	22	50	90	Ø20x70	4/M4/36
A9130M20	30	60	90	Ø20x70	4/M6/48 - 4/M5/45

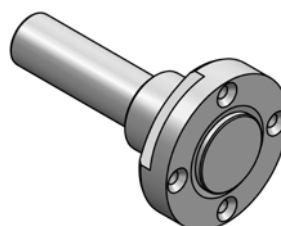
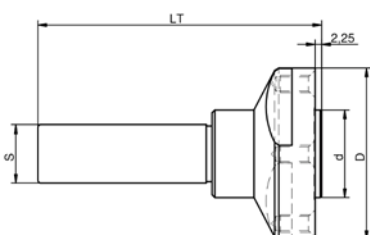

10AC

Juego 2 anillos para reducción de eje

Jeu de 2 bagues de réduction

	D	d	E
A104030	40	30	8
A105030	50	30	8
A105035	50	35	8
A105040	50	40	8

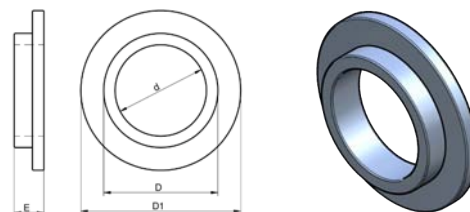

20AC

Anillos de separación

Bagues de séparation

	D	d	E
A20H01	50	30	0.1
A20H02	50	30	0.2
A20H03	50	30	0.3
A20H05	50	30	0.5
A20H10	50	30	1
A20J01	60	40	0.1
A20J02	60	40	0.2
A20J03	60	40	0.3
A20J05	60	40	0.5
A20J10	60	40	1
A20K01	70	50	0.1
A20K02	70	50	0.2
A20K03	70	50	0.3
A20K05	70	50	0.5
A20K10	70	50	1
A20L01	80	60	0.1
A20L02	80	60	0.2
A20L03	80	60	0.3
A20L05	80	60	0.5
A20L10	80	60	1

A20HJO	50	30	Juego/Jeu
A20JJO	60	40	Juego/Jeu
A20KJO	70	50	Juego/Jeu
A20LJO	80	60	Juego/Jeu

Juego/ Jeu: 0.1, 0.2, 0.3, 0.5, 1mm

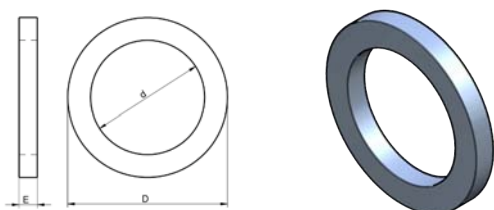

25AC

	D	d	E
A25MJ02	50	30	2
A25MJ04	50	30	4
A25MJ08	50	30	8
A25MJ16	50	30	16
A25MJ20	50	30	20
A25MJ30	50	30	30
A25OM02	60	40	2
A25OM04	60	40	4
A25OM08	60	40	8
A25OM16	60	40	16
A25OM20	60	40	20
A25OM30	60	40	30
A25QN02	70	50	2
A25QN04	70	50	4
A25QN08	70	50	8
A25QN16	70	50	16
A25QN20	70	50	20
A25QN30	70	50	30
A25RO02	80	60	2
A25RO04	80	60	4
A25RO08	80	60	8
A25RO16	80	60	16
A25RO20	80	60	20
A25RO30	80	60	30
A25SQ02	90	70	2
A25SQ04	90	70	4
A25SQ08	90	70	8
A25SQ16	90	70	16
A25SQ20	90	70	20
A25SQ30	90	70	30

15AC

Anillos reducción de eje para discos Bagues de réduction pour lames circulaires

	D	d	E
A15E3016	30	16	2
A15E3020	30	20	1.8
A15E3022	30	22	2
A15E3018	30	18	2
A15E3516	35	16	2
A15E3525	35	25	2
A15E3530	35	30	1.8
A15E4025	40	25	2
A15E4032	40	32	2
A15E4035	40	35	2
A15E5035	50	35	2

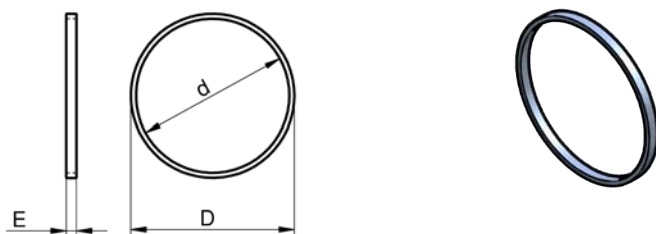

45AC

Cojinete tope Roulements à billes et bagues de guidage

	D	d	E	
A45080	80	50	16	Rodamiento/Roulement
A45090	90	80	20	Anillo reductor/Bague de réduction
A45100	100	80	20	Anillo reductor/Bague de réduction
A45120	120	80	20	Anillo reductor/Bague de réduction
A45125	125	80	20	Anillo reductor/Bague de réduction
A45140	140	80	20	Anillo reductor/Bague de réduction
A45JGO		50	20	Juego completo/Jeu complet

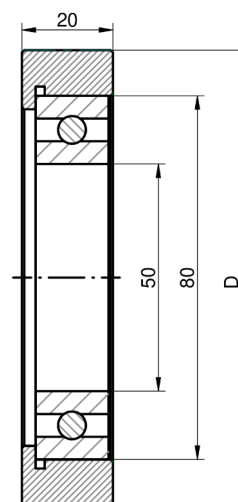

95AC

Tornillos, tuercas, espárragos y llaves Vis, écrous et clés

95AC01 Espárrago Punta Cil. Vis Pointe Cil.	d	L	v	d2	S	Llave / Clé
A95M0510	M5	12	2	2.5	2	A9518L20
A95M0516	M5	10	2.5	3.5	2.5	A9518L25
A95M0610	M6	10	3	4	3	A9518L39
A95M0612	M6	12	3	4	3	A9518L39
A95M0616	M6	16	3	4	3	A9518L39
A95M0620	M6	20	3	4	3	A9518L39
A95M0810	M8	10	4	5.5	4	A9518L41
A95M0812	M8	12	4	5.5	4	A9518L41
A95M0816	M8	16	4	5.5	4	A9518L41
A95M0820	M8	20	4	5.5	4	A9518L41
A95M0825	M8	25	4	5.5	4	A9518L41
A95M1020	M10	20	5	7	5	A9518L51
A95M1030	M10	30	5	7	5	A9518L51
A95M1225	M12	25	6	8	6	A9518L62

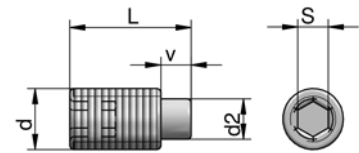

95AC02 Espárrago / Vis	d	L	S	Llave / Clé
A95C0506	M5	6	2.5	A9518L25
A95C0510	M5	10	2.5	A9518L25
A95C0606	M6	6	3	A9518L39
A95C2503	M2.5	3	1.2	A9518L12

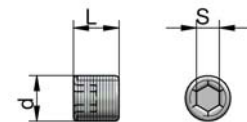

95AC03 Espárrago Rosca D+1 Vis Filetage D+1	d1/d2	L	A	B	C	Ø	S	Llave / Clé
A95I0515	M5	15	5.5	4	5.5	3.6	2.5	A9518L25
A95I0622	M6	22	9	4	9	4.6	3	A9518L39
A95I0822	M8	22	9	4	9	6.4	4	A9518L41
A95I1022	M10	22	9	4	9	7.6	5	A9518L51

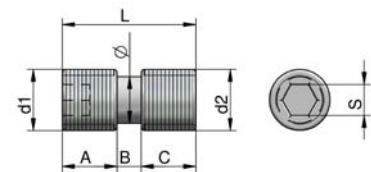

95AC04 Tuerca Amarre Radial Écrou Fixation Radial	d	L	D	d1
A9540507	M5	7	7.5	6
A9540608	M6	8	9.9	8
A9540885	M8	8.5	13	11.2

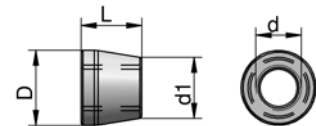

95AC06 Tuerca / Écrou	M	L	D	d
A956M0416	M4	1.6	9.9	8.45
A956M0422	M4	2.2	11.8	8.45
A956M0432	M4	3.2	11.8	8.45

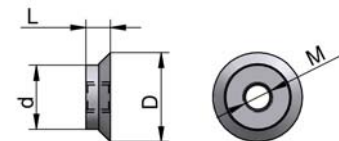

95AC07 Tuerca / Écrou	d	L	D
A957M0411	M4	1.1	10.2
A957M0417	M4	1.7	11.9

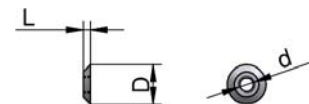

95AC10 Tornillo Allen / Vis Allen	d	L	K	D	S	Llave / Clé
A9510304R	M3	4	3	5.5	2.5	A9518L25
A9510306	M3	6	3	5.5	2.5	A9518L25
A9510410	M4	10	4	7	3	A9518L41
A9510518	M5	18	5	8.5	4	A9518L41
A9510614	M6	14	6	10	5	A9518L51
A9510616	M6	16	6	10	5	A9518L51
A9510618	M6	18	6	10	5	A9518L51
A9510620	M6	20	6	10	5	A9518L51
A9510818	M8	18	8	13	6	A9518L62
A9510825	M8	25	8	13	6	A9518L62

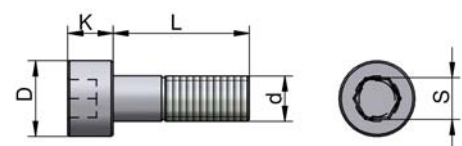

95AC

Tornillos, tuercas, espárragos y llaves Vis, écrous et clés

95AC11 (ALLEN)	d	L	K	D	S	Llave / Clé
A9511308	M3	8	1.5	5.3	2	A9518L20
A9511408	M4	8	2	7.3	2.5	A9518L25
A9511618	M6	18	3	10.2	4	A9518L41
A9511620	M6	20	3	10.2	4	A9518L41

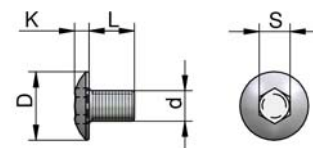

95AC12 (TORX)	d	L	K	D	S	Llave / Clé
A95124D6	M4	4	2.2	6	T15	A9517510
A95124D9	M4	4	2.2	9	T15	A9517510
A9512406	M4	6	2.2	9	T15	A9517510
A95126D6	M4	6	2.2	6	T15	A9517510
A9512408	M4	8	2.2	9	T15	A9517510
A9512356	M3.5	6	2.2	6	T15	A9517510

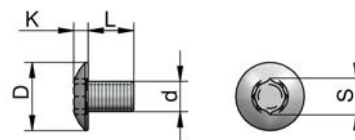

95AC13	d	L	K	D	S	Llave / Clé
A9513310	M3	10	1.7	6	2	A9518L20
A9513408	M4	8	2.3	8	2.5	A9518L25
A9513512	M5	12	2.8	10	3	A9518L39
A9513525	M5	25	2.8	10	3	A9518L39
A9513616	M6	16	3.3	12	4	A9518L41
A9513625	M6	25	3.3	12	4	A9518L41
A9513812	M8	12	4.4	16	5	A9518L41
A9513102	M10	20	5.5	20	6	A9518L62

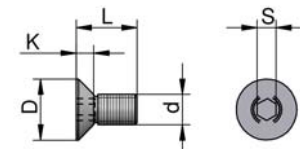

95AC14 Dest. Plano / Dest. Plate	d	L	K	D
A9514508	M5	7	2	8.9

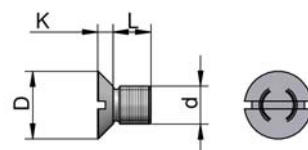

95AC15	d	L	K	D	S	Llave / Clé
A9515432	M4	3.2	1.1	6	2 Pasante	A9518L20
A9515442	M4	4.2	1.1	6	T9	A9517910
A9515465	M4	6.5	1.1	6	T9	A9517910
A9515560	M5	6.5	2	8.9	T20	A9517520
A9515595	M5	10	2	8.9	T20	A9517520

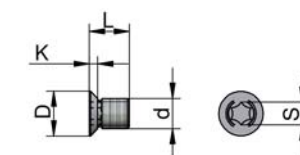

95AC17 (TORX)	T	LT
A9517910	T9	100
A9517510	T15	100
A9517520	T20	100



95AC18 (ALLEN)	Serie	S
A9518L04	Acodada / Forme "L"	4
A9518L12	Acodada / Forme "L"	1.27
A9518L15	Acodada / Forme "L"	1.5
A9518L20	Con empuñadura / Avec poignée	2
A9518L25	Con empuñadura / Avec poignée	2.5
A9518L39	Con empuñadura / Avec poignée	3
A9518L41	Con empuñadura / Avec poignée	4
A9518L51	Con empuñadura / Avec poignée	5
A9518L62	Con empuñadura / Avec poignée	6

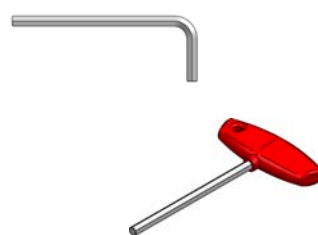

95AC

Tornillos, tuercas, espárragos y llaves Vis, écrous et clés

95AC19 Llave Uña/Clé crochet	Descripción/Description	L
A9519U45	ER25 (45-50)	205
A9519U48	ER40 (58-62)	240
A9519U52	ER32 (52-55)	205
A9519U68	KM10 (68-75)	240
A9519U80	KM12 (80-90)	280



95AC21 (con Guía/avec Guide)	d	L	B	d1	C	K	D	Llave / Clé
A9521511	M5	11.5	5	6	4.5	2	10	A9517520
A9521513	M5	13.5	6	6	5.5	2	10	A9517520
A9521513R	M5	13	6	6	5.5	1.5	9	A9517520

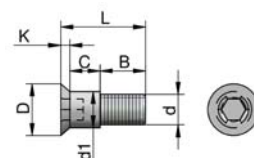

95AC22 Cabeza Reducida Tête Réduite	d	L	K	D	S	Llave / Clé
A9522516	M5	16	3.4	8.4	3	A9518L39
A9522620	M6	20	4	10	5	A9518L51

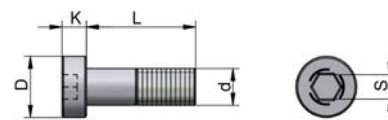

95AC23 Tornillo/Vis HSK25	Descripción/Description	Llave / Clé
A9523135	M10x35 HSK25	Allen 10



95AC25 Tuerca Amarre Radial Écrou Fixation Radial	d	D	L	Rosca/Filetage
A9525808	M8	14.9	8	Sx.
A9525813	M8	14.9	13	Sx.
A9525113	M10	14.9	13	Sx.

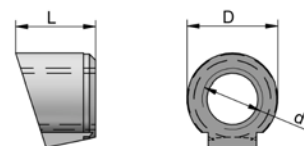

95AC35 Anilla/Bague	D	d	S
A9535D12	12	4.1	3
A9535D10	10.5	4.1	2.5

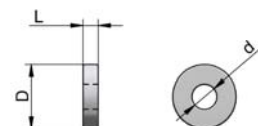

95AC39 Cab. Cuadrada Tête Carrée	d	L	K	A	CH
A9539M12	M10	17	5	12	10
A9539M14	M10	22	6	14	10
A9539M16	M10	22	6	16	12

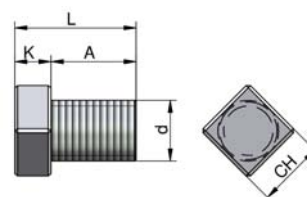

01SC

Discos **MD** rectos para ranurar
Lames circulaires **HM** droits à rainer

	D	LC	d	Z
S01BA02	125	2(1.2)	30	12
S01BA03	125	3(2)	30	12
S01BA04	125	4(2.8)	30	12
S01BA05	125	5(4)	30	12
S01BA06	125	6(4)	30	12
S01BB02	150	2(1.4)	30	18
S01BB25	150	2.5(1.6)	30	18
S01BB03	150	3(2)	30	18
S01BB35	150	3.5(2.5)	30	18
S01BB04	150	4(2.8)	30	18
S01BB05	150	5(4)	30	18
S01BB06	150	6(4)	30	18
S01BC04	250	4(2.8)	30	40



05SC

Discos **MD** alternos con limitador
Lames circ. **HM** alternés à déligner, avec limiteurs

	D	LC	d	Z
S05B300S	300	3.2(2.2)	30	28
S05B350S	350	3.5(2.5)	30	32



07SC

Discos **MD** alt., corte longitudinal maderas gruesas
Lames circulaires **HM** alternées, pour déligner

	D	LC	d	Z
S07B300S	300	3.2(2.2)	30	28
S07B350S	350	3.5(2.5)	30	32



12SC

Discos MD alternos para múltiple
Lames circ. HM alternées, déligneuse multiple

	D	LC	d	Z
S12BC353S	350	3.5(2.5)	30	24+6
S12BC357S	350	3.5(2.5)	70+2kw	24+6

**15SC**

Discos MD alternos, universal
Lames circulaires HM alternées, universelles

	D	LC	d	Z
S15B250S	250	3.2(2.2)	30	48
S15B300S	300	3.2(2.2)	30	48
S15B350S	350	3.5(2.5)	30	54
S15B400S	400	4(2.8)	30	60

**26SC**

Discos MD alternos para tableros
Lames circulaires HM alternées, panneaux

	D	LC	d	Z
S26B250S	250	3.2(2.2)	30	60
S26B300S	300	3.2(2.2)	30	72

**28SC**

Discos MD trapecio-plano para paneles recubiertos
Lames circ. HM trapézoïdal-plate, panneaux revêtus

	D	LC	d	Z
S28B300S	300	3.2(2.2)	30	72



30SC

Discos **MD** alternos para paneles recubiertos
Lames circulaires **HM** alternées, panneaux revêtus

	D	LC	d	Z
S30B300S	300	3.2(2.2)	30	96



31SC

Discos **MD** alternos "Coated", paneles recubiertos
Lames circ. **HM** alt. "Coated", panneaux revêtus

	D	LC	d	Z
S31B300S	300	3(2.5)	30	96



32SC

Discos **MD** trapecio-plano, paneles recubiertos
Lames circ. **MD** trapézoïdal-plate, panneaux revêtus

	D	LC	d	Z
S32B250S	250	3.2(2.2)	30	80
S32B300S	300	3.2(2.2)	30	96

Japan Tech



32SD

Discos **PCD H6** trapecio-plano, paneles recubiertos
Lames circ. **PCD H6** trapézoïdal-plate, panneaux revêtus

	D	LC	d	Z
S32D300S	300	3.2	30	96



36SC

Discos **MD** trapecio-plano seccionadora
 Lames circ. **HM** trapézoïdal-plate, scie à panneaux

	D	LC	d	Z
S36B301S	300	4.4(3.2)	30	72
S36B350S	350	4.4(3.2)	30	72
S36B351S	350	4.4(3.2)	75	72
S36B407S	400	4.4(3.2)	75	72

Japan Tech

**38SC**

Discos incisores **MD** cónicos
 Inciseurs **HM** denture conique

	D	LC	d	Z
S38B12020S	120	3.1/4.3	20	24
S38B12022S	120	3.1/4.3	22	24
S38B12520S	125	3.1/4.3	20	24
S38B12522S	125	3.1/4.3	22	24
S38B18030S	180	4.4/5.6	30	36
S38B20045S	200	4.4/5.6	45	36

**40SC**

Discos incisores **MD** extensibles
 Inciseurs **HM** extensibles

	D	LC	d	Z
S40B120S	120	2.8/3.6	20	12+12



43SC

Discos **MD** trapecio-plano neg. para aluminio
Lames circ.s **HM** trapézoïdal-plate nég., pour aluminium

	D	LC	d	Z
S43BC094S	250	3.2	30	80
S43BC096S	300	3.2	30	96
S43BC097S	300	3.2	32	96
S43BE108S	350	3.6	30	108
S43BE109S	350	3.6	32	108

Japan Tech



48SC

Discos **MD** para trirurador
Lames circulaires **HM** pour déchiqueteur

	D	LC	d	Z	Posición Trabajo
S48B255AD	255	4.1(2.8)	130	40	48/1
S48B255AI	255	4.1(2.8)	130	40	48/2
S48B255BD	255	4.1(2.8)	130	58	48/1
S48B255BI	255	4.1(2.8)	130	58	48/2

Japan Tech

POSICION DE TRABAJO

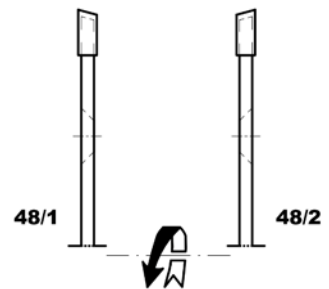

POSITION DE TRAVAIL

S54SR

Segmento/Segment D250x4 Z10

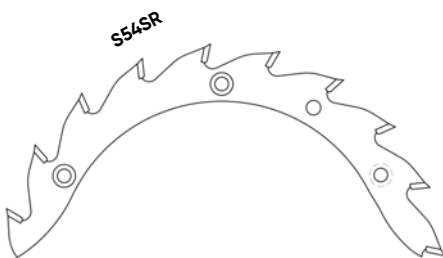

54SC

Triturador en aluminio (Sin disco 48SC)
Déchiqueteur en aluminium (Sans lame 48SC)

	D	LC	d
S54JD	250	30	80
S54JI	250	30	80

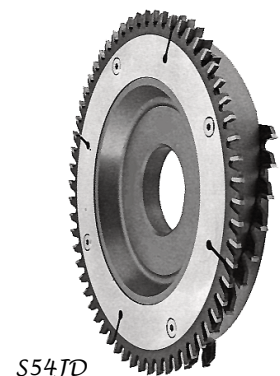

S54JD

**Referencias para la
fabricación de
herramientas
especiales.**

***Références pour la
fabrication d'outils
spéciaux.***



44BH

Broca escalonada **Especial** (MD/HSS) Mango cilíndrico
 Mèche étagée **Spéciale** (HM/HSS) Queue cylindrique

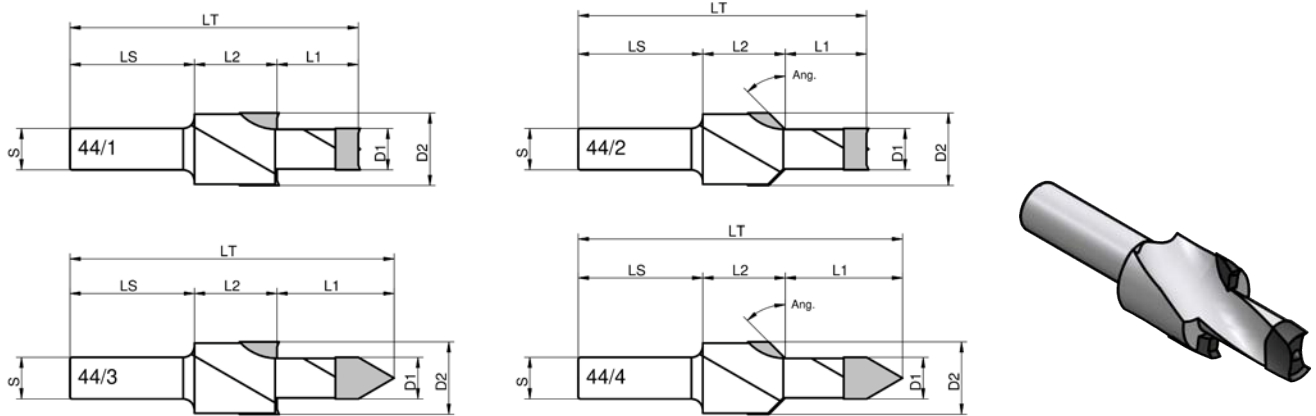

77FM

Cabezales de **"ALAMBOR"**
 Porte-outils pour contour de porte

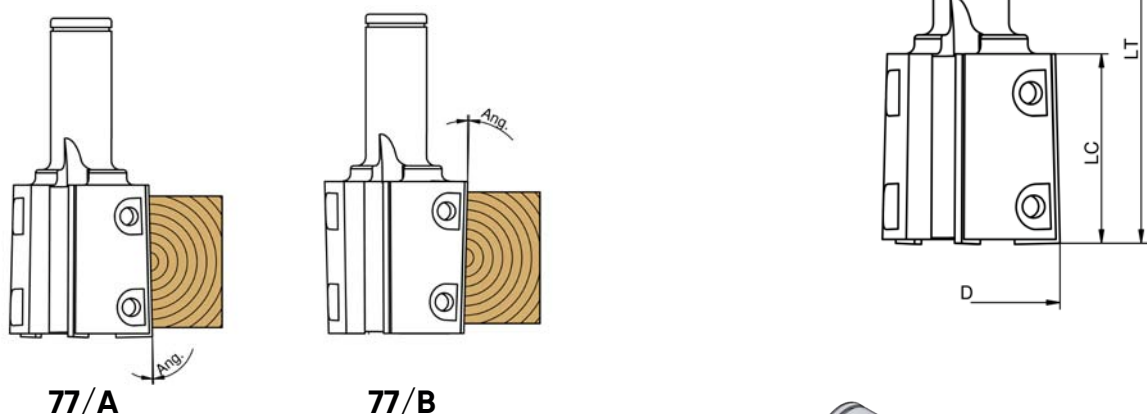

57FR

Fresas de moldura
Fraises à profiler

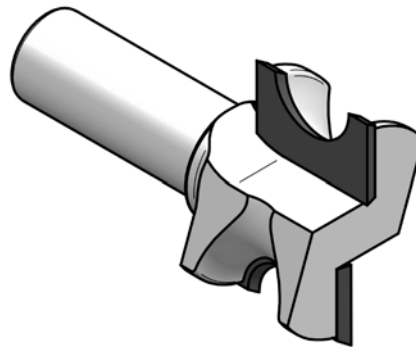
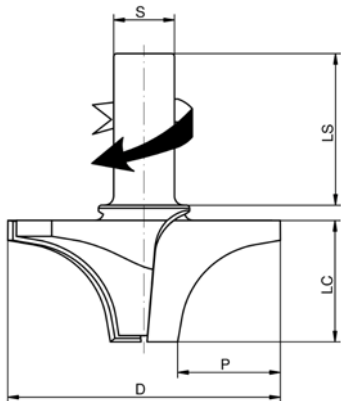

57FD

Fresas PCD de moldura
Fraises PCD à profiler

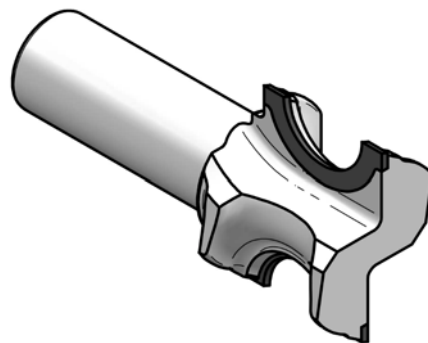
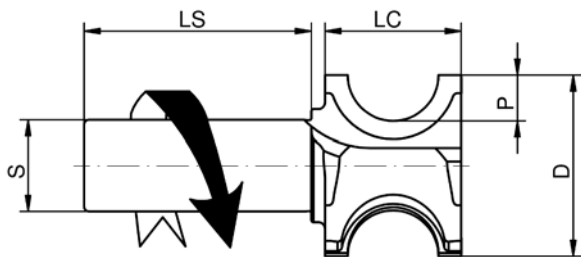

76CB

Cabezales MD de moldura
Porte-outils HM à profiler

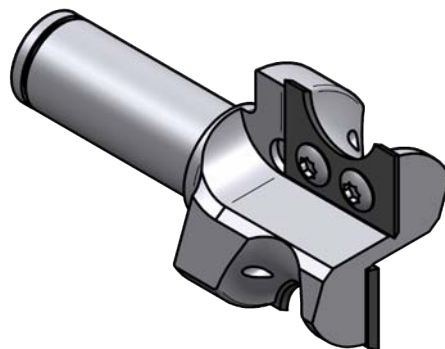
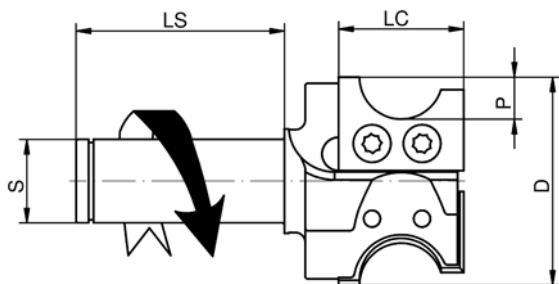

01FR

Fresas rectas sin axial
Fraises droites sans angle axial

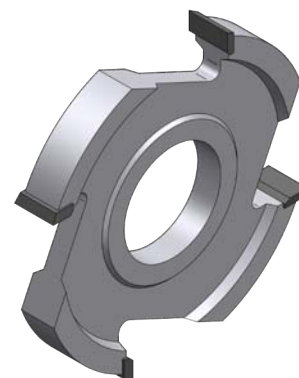
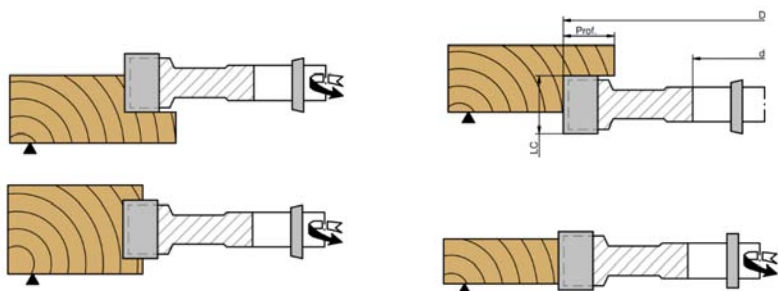

02FR

Fresas rectas axial alterno
Fraises droites, dents alternées

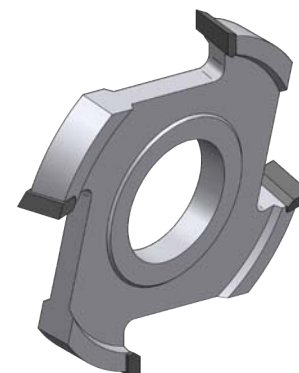
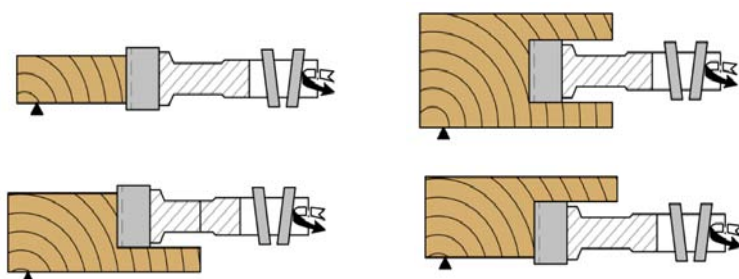

03FR

Fresas rectas con precortadores
Fraises droites avec araseurs

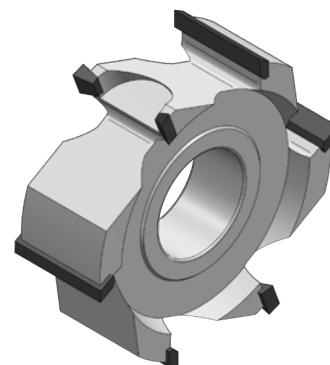
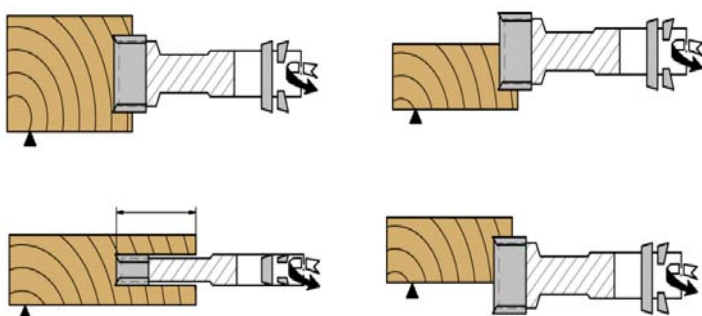

01CB

Cabezales **MD** rectos con precortadores
Porte-outils **HM** droits avec araseurs

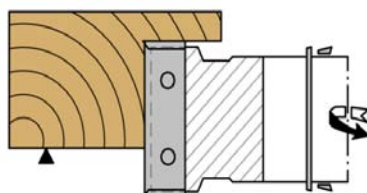
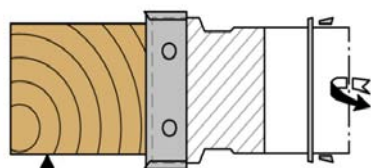
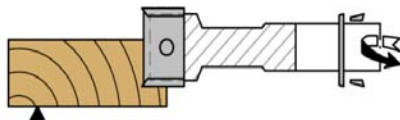
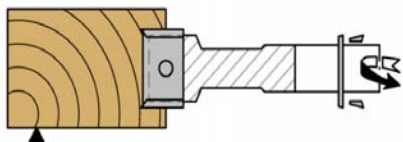

06CB

Cabezales **MD** rectos
Porte-outils **HM** droits

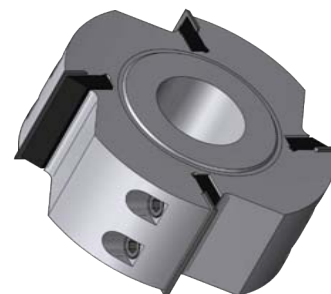
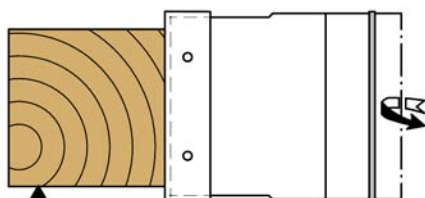

17CB

Cabezales **MD** para ranuras estrechas
Porte-outils **HM** pour rainures fines

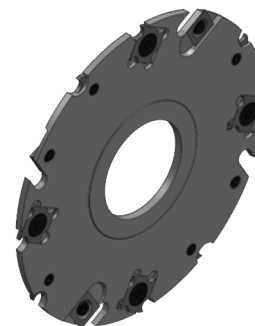
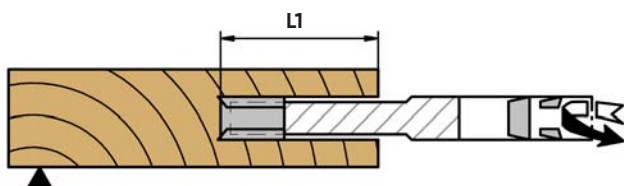

18CB

Cabezales **MD** extensibles (estrechos)
 Porte-utiles **HM** extensibles (fines)

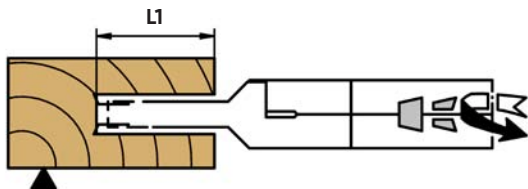

02FD

Fresas **PCD H4** para cantear
 Fraises **PCD H4** pour plaqueuse de chant

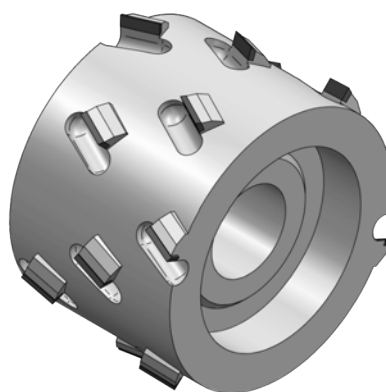
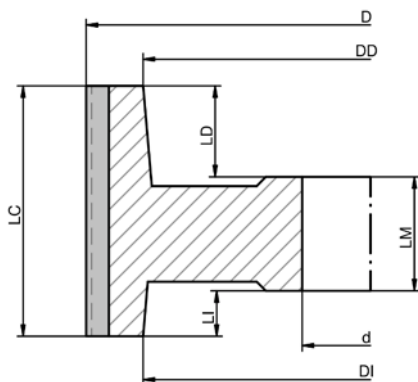

TIPO AXIAL:

TYPE AXIAL:

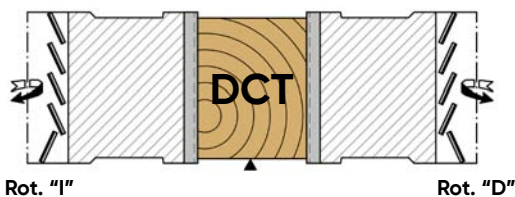

FORMA:

FORME:

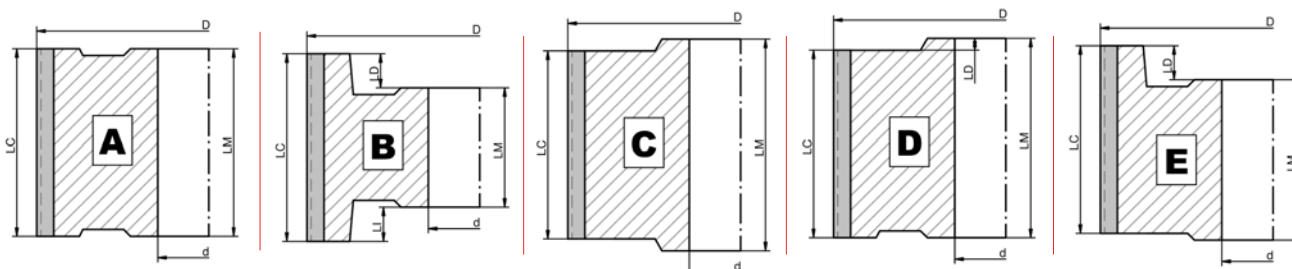

03FD

Fresas **PCD** rectas
Fraises **PCD** droites

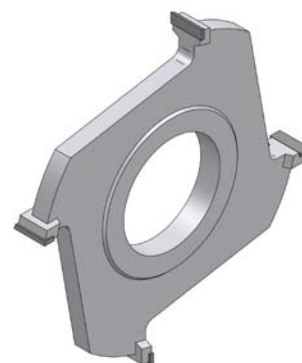
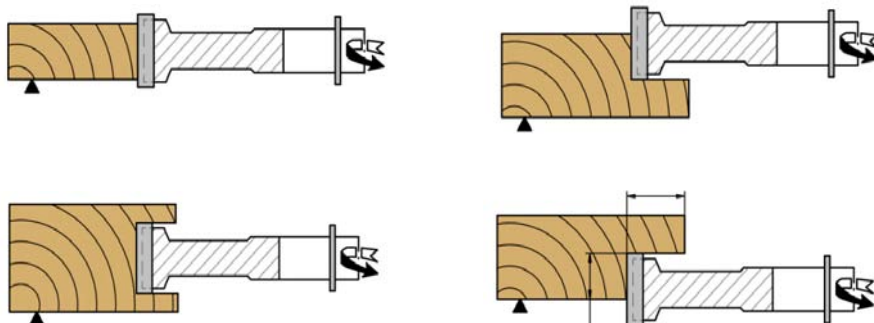

13FD

Fresas **PCD** extensibles para ranurar
Fraises **PCD** extensibles à rainer

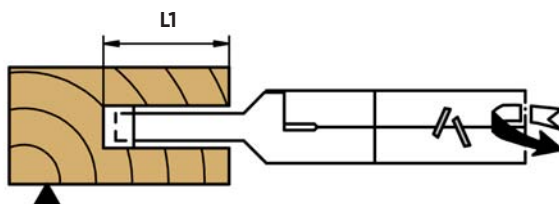

04FD

Fresas **PCD** extensibles para cantear
Fraises **PCD** extensibles à chants

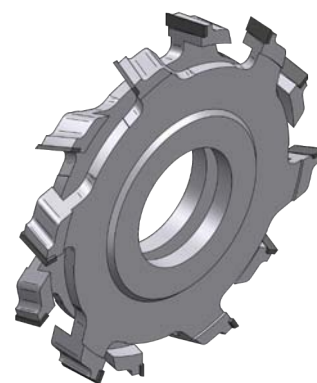
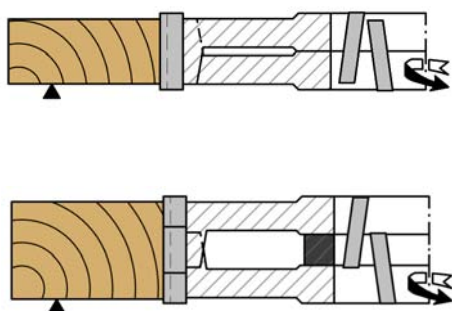

FRESAS Y CABEZALES PARA ESPIGAR FRAISES ET PORTE-OUTILS À TENONNER

70FR

Fresas para espigar
Fraises à tenonner

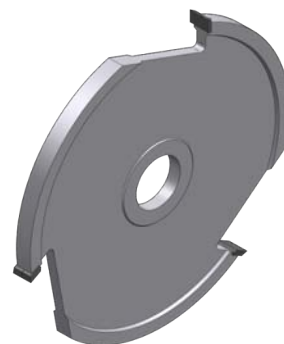
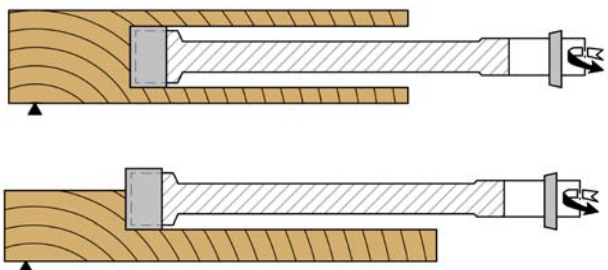

71FR

Fresas con precortadores para espigar
Fraises avec araseurs à tenonner

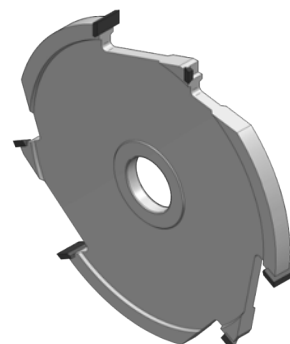
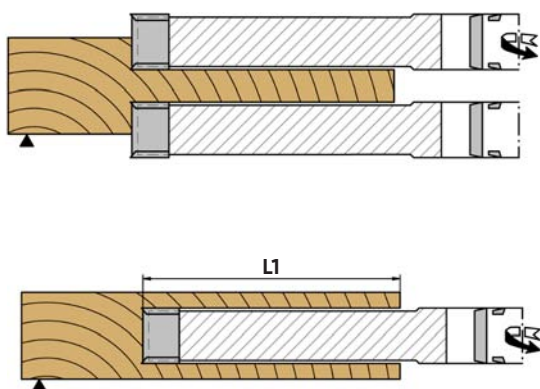

95CB

Cabezales **MD** con precortadores para espigar
*Porte-outils **HM** avec araseurs à tenonner*

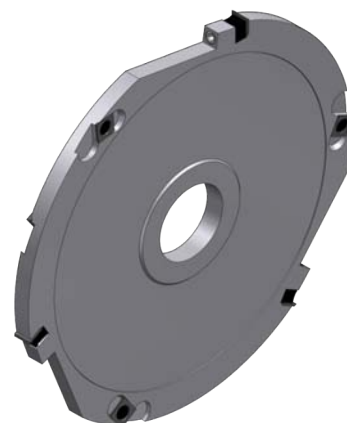
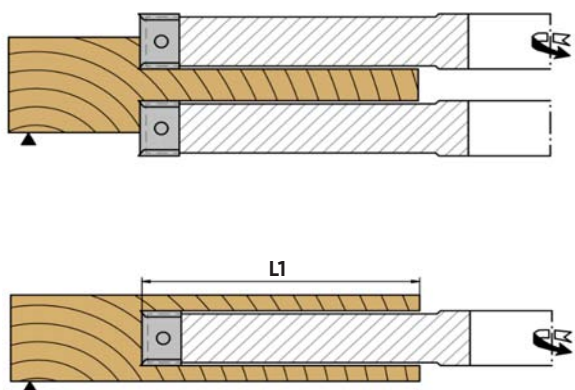

CABEZALES PARA CEPILLAR / GUÍA PORTE-OUTILS À RABOTER / PRÉDÉGAUCHISSAGE

24CB

Cabezales para cepillar (CUCHILLAS 12CR HSS)
Porte-outils à raboter (PLAQUETTES 12CR HSS)

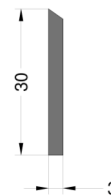
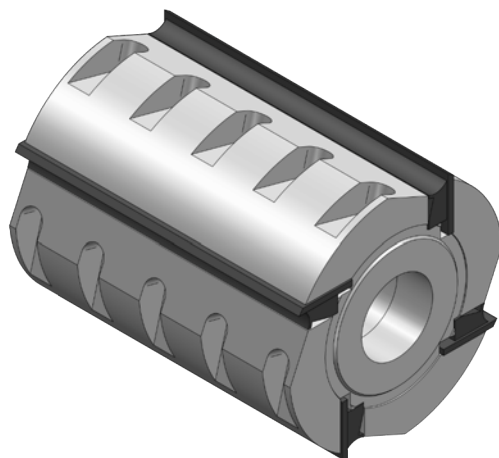
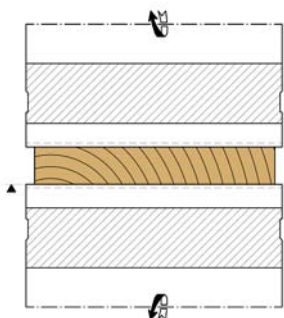

25CB

Cabezales para cepillar (CUCHILLAS CENTROLOCK HSS)
Porte-outils à raboter (PLAQUETTES CENTROLOCK HSS)

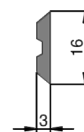
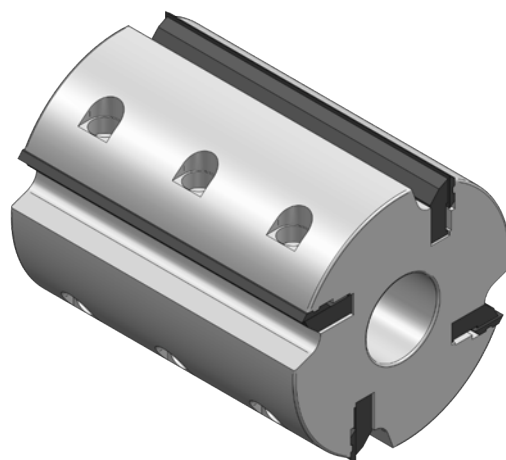
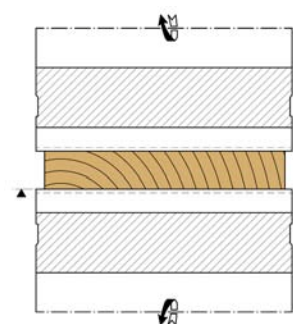

32CB

Cabezales **MD** para galce de guía en moldurera
Porte-outils **HM** de prédégauchissage

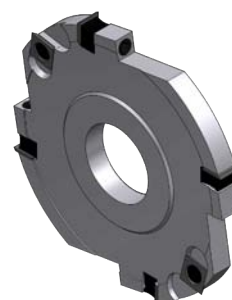
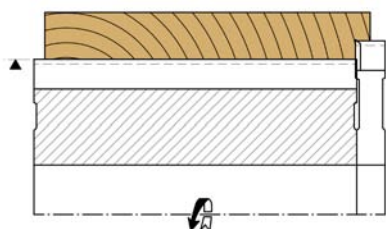

27CB

Cabezales helicoidales **MD** para cepillar
*Porte-outils helicoidaux **HM** à raboter*

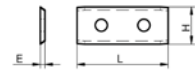
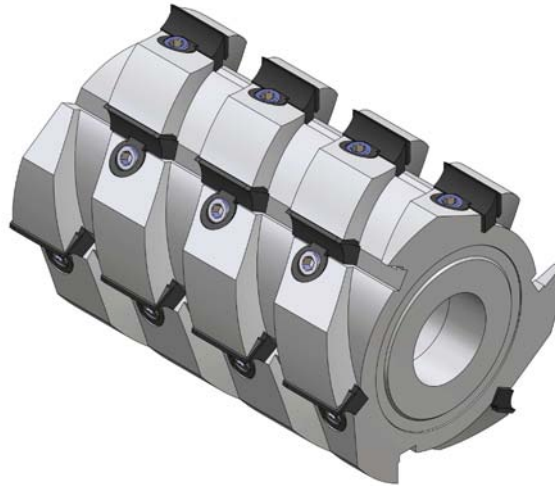
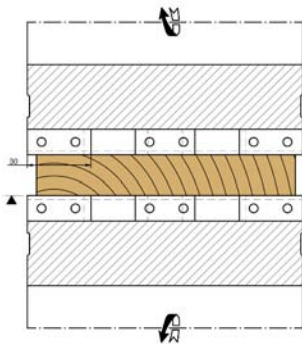

28CB

Cabezales helicoidales **MD** para cepillar
*Porte-outils helicoidaux **HM** à raboter*

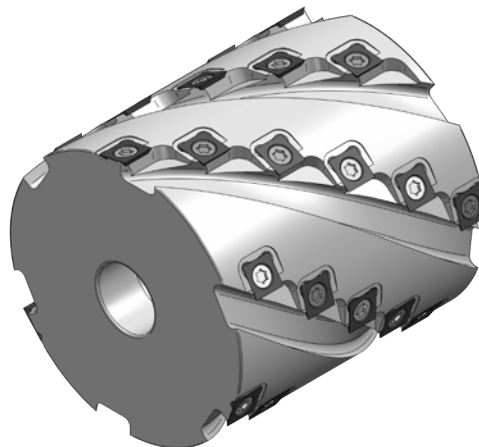
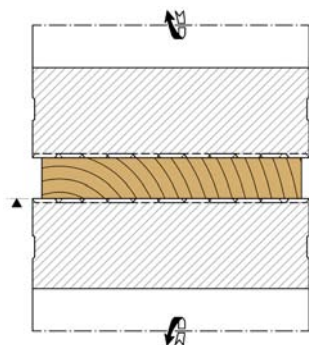

19FR

Fresas para biselar
 Fraises à chanfreiner

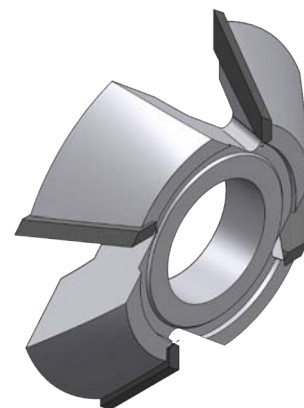
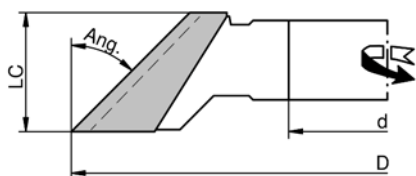
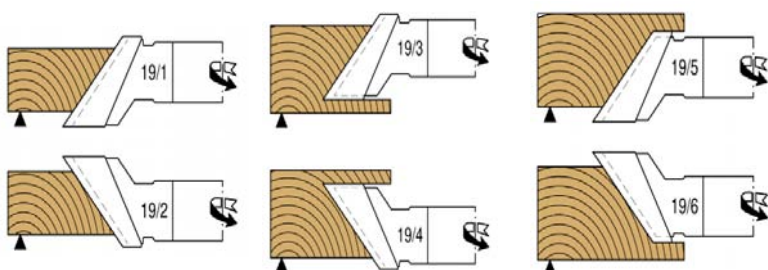

19FD

Fresas **PCD** para biselar
 Fraises **PCD** à chanfreiner

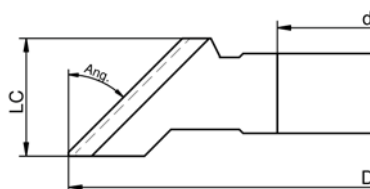
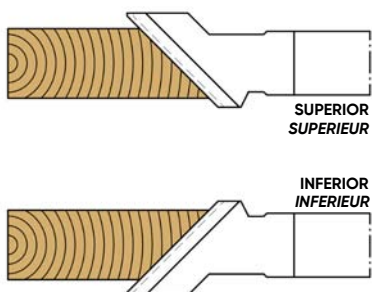

41CB

Cabezales **MD** para biselar
 Porte-outils **HM** à chanfreiner

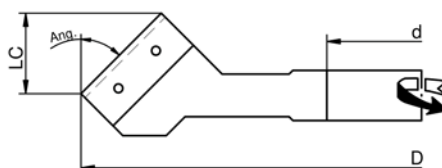
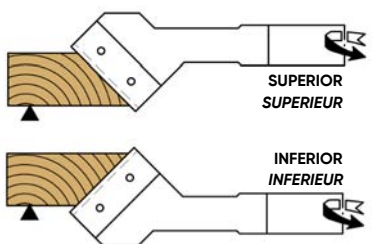

26FR

Fresas para juntas
Fraises pour joints collés

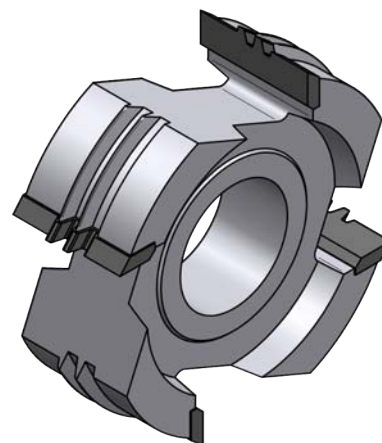
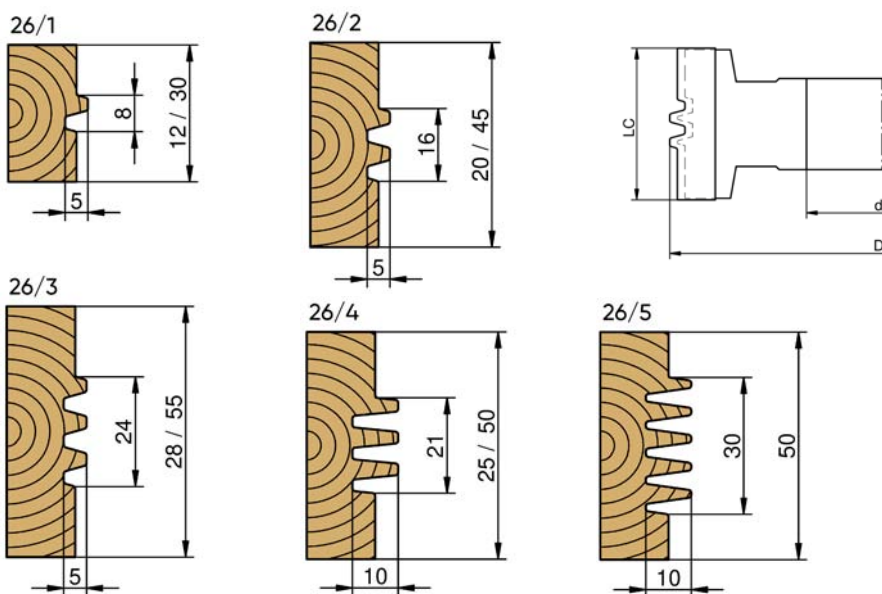

28FR

Fresas para juntas encoladas
Fraises pour joints collés

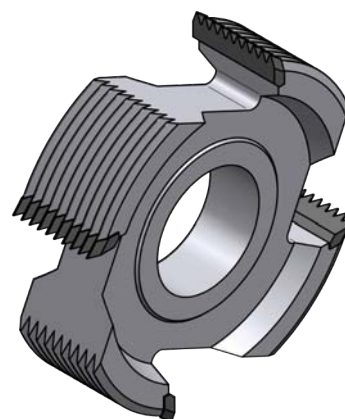
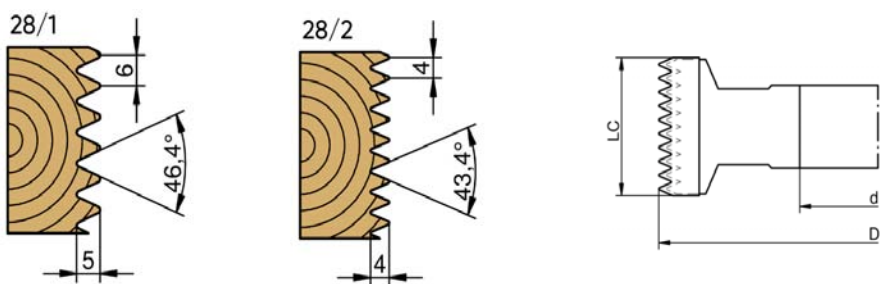

FRESAS MACHIHEMRADO / FRAISES À RAINURE-LANGUETTE

31FR

Juego fresas machihembrado perfiles rectos
 Jeu Fraises à rainure-languettes profil droit

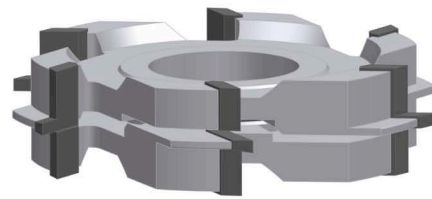
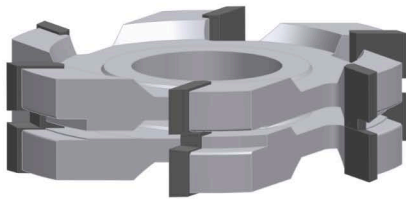
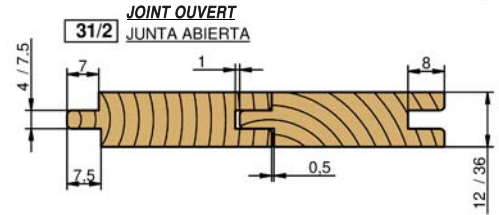
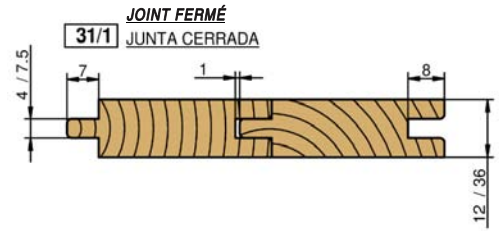
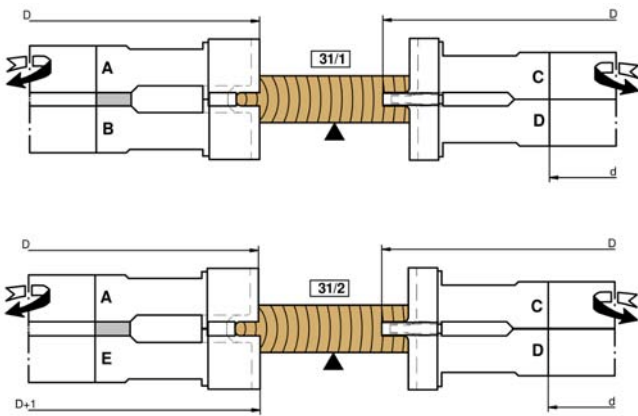

POSICIONES DE TRABAJO POSITIONS DE TRAVAIL

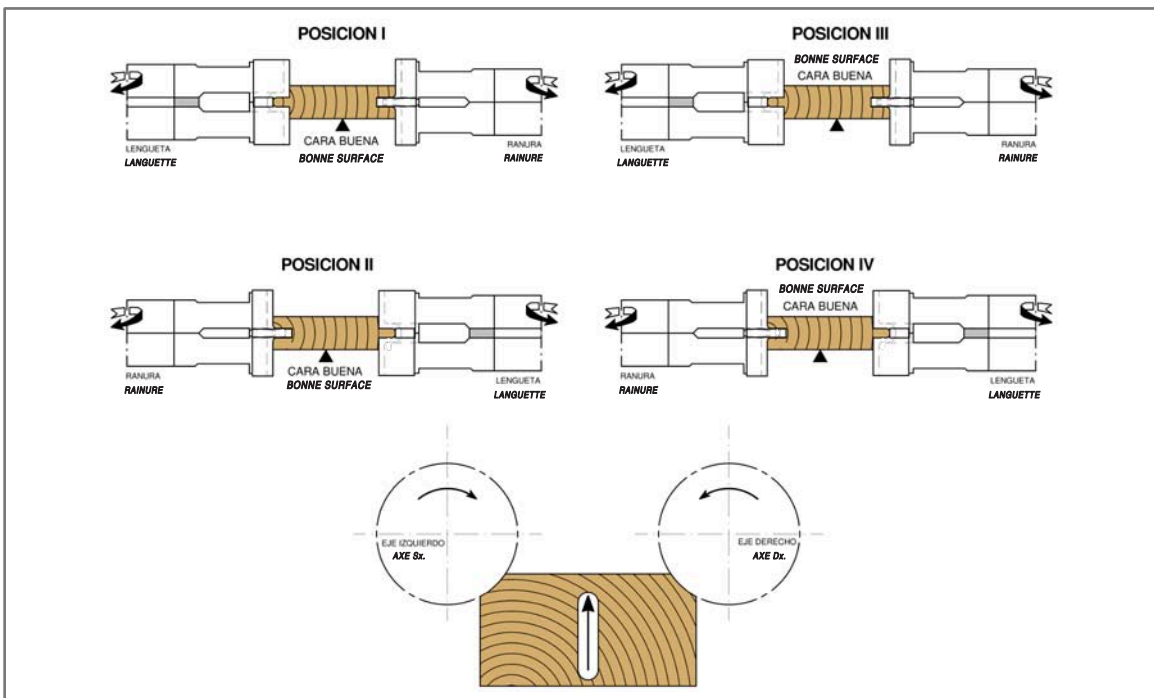

32FR

Juego fresas machihembrado perfiles decorativos Jeu Fraises à rainure-languette profil décoratif

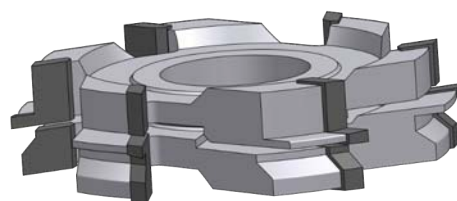
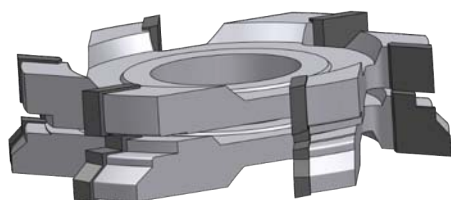
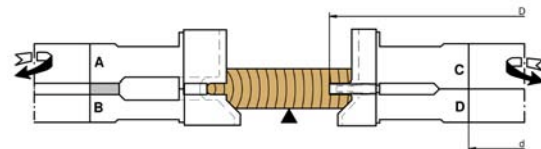
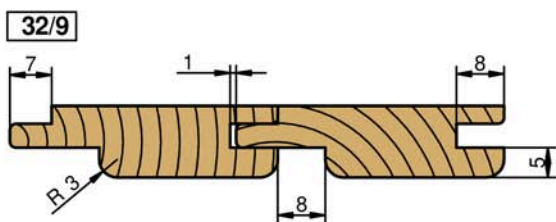
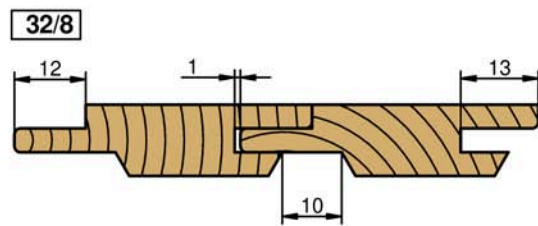
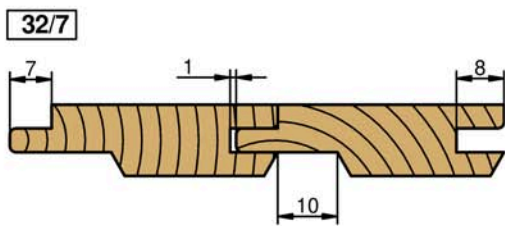
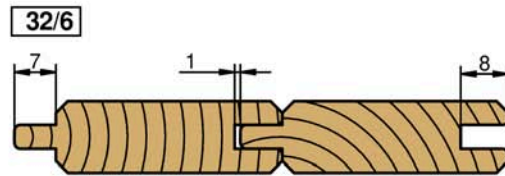
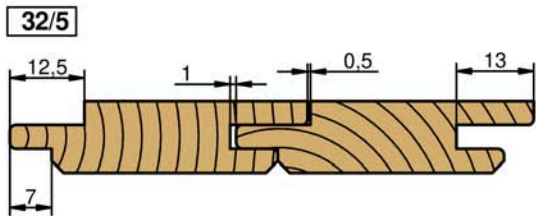
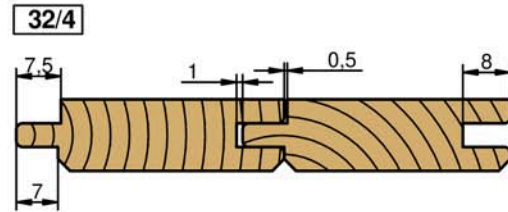
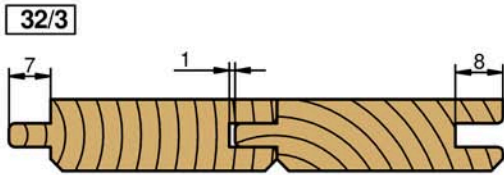
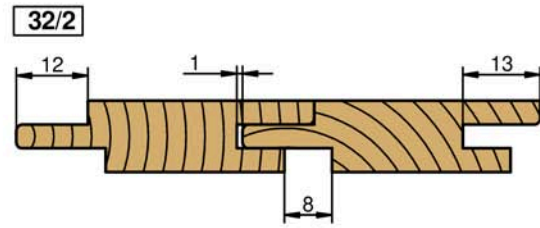
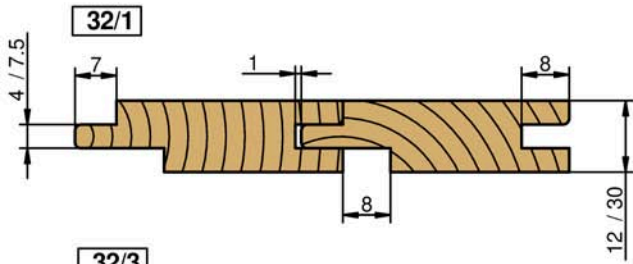

43FR

Fresas de moldura
Fraises à profiler

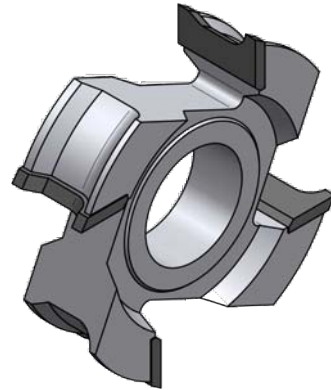
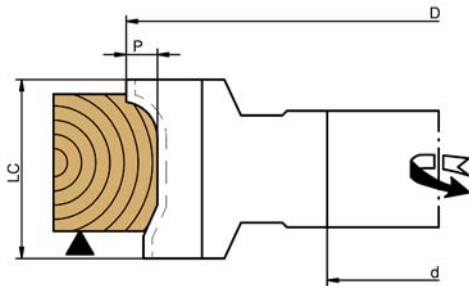

58FR

Fresas para un palo redondo
Fraises à 1 bâton rond

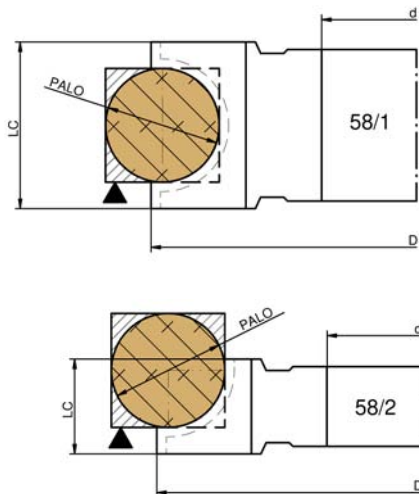

58FR

Fresas para varios palos redondos
Fraises à plusieurs bâtons ronds

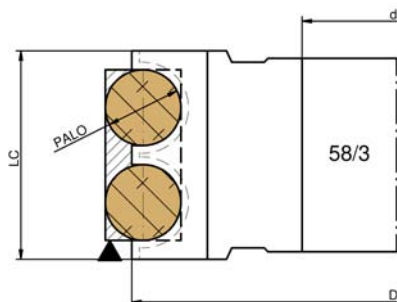

43FD

Fresas **PCD** de moldura
 Fraises **PCD** à profiler

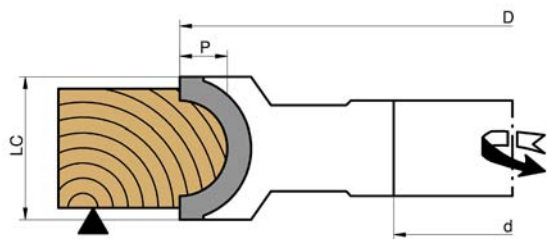

72CB

Cabezales **MD** de moldura
 Porte-outils **HM** à profiler

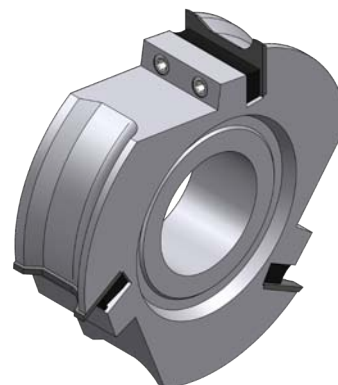
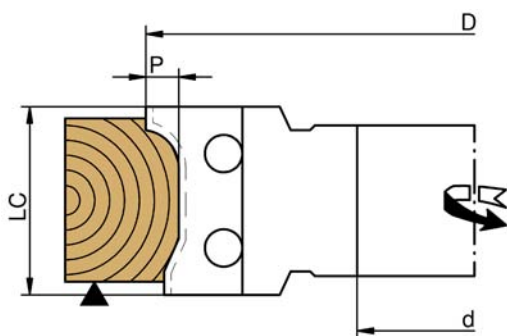

40CB

Cabezales **MD** para ranurar "ALUCOBOND"
 Porte-outils **HM** à rainier "ALUCOBOND"

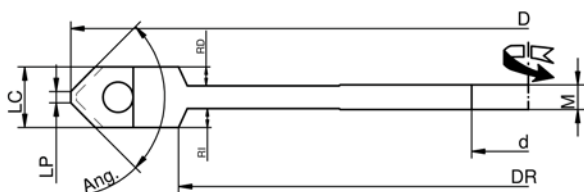

Ejemplos / Exemples :

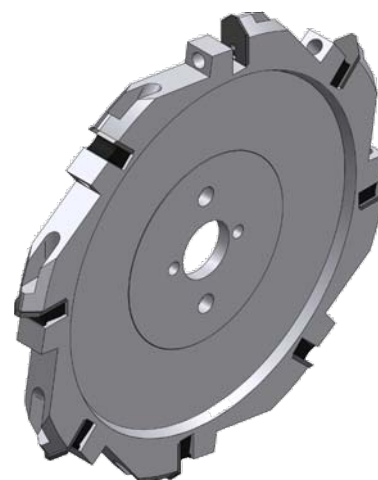
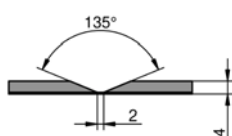
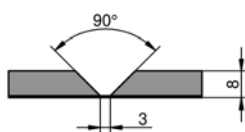

72FR

Fresas de contramoldura (Sin precortadores)
Fraises à contre profil (Sans araseurs)

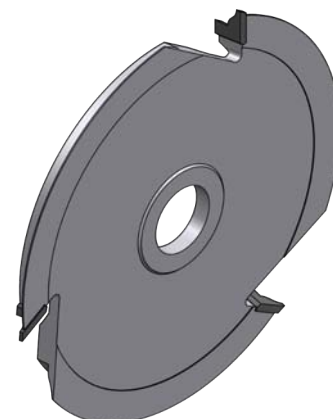
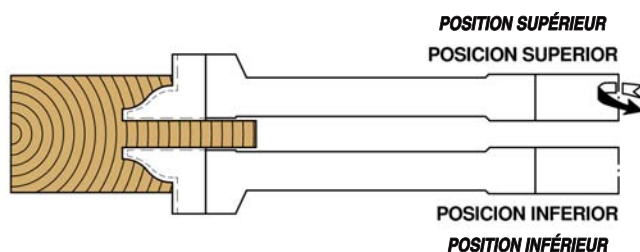

73FR

Fresas de contramoldura (Con precortadores)
Fraises à contre profil (Avec araseurs)

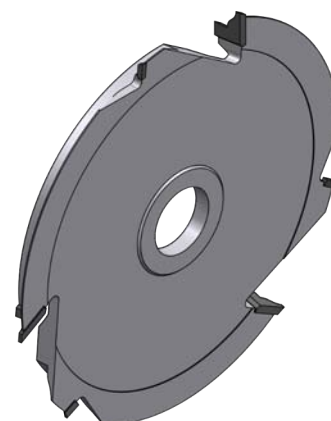
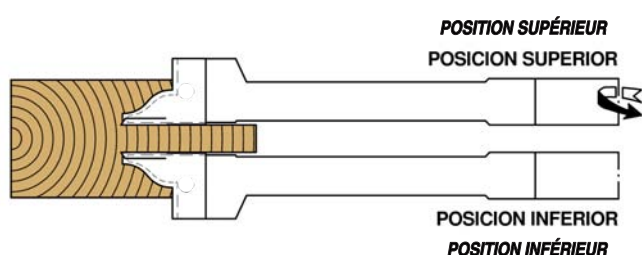

97CB

Cabecal **MD** de contramoldura (Con precortadores)
Porte-outils **HM** à contre profil (Avec araseurs)

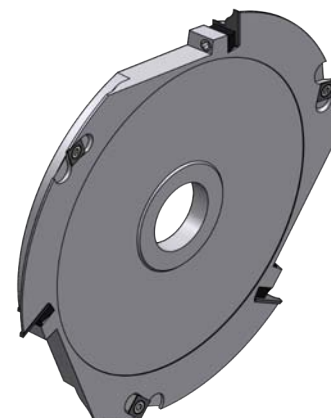
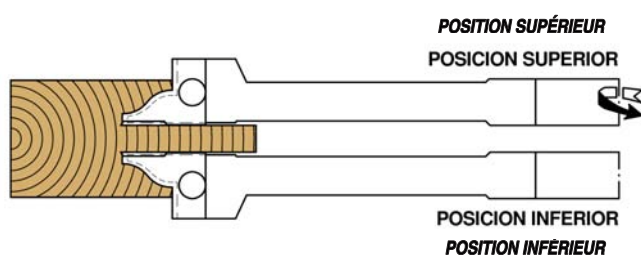

30CR

Cuchillas de moldura **MD**
 Plaquettes à profiler **HM**

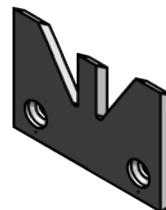
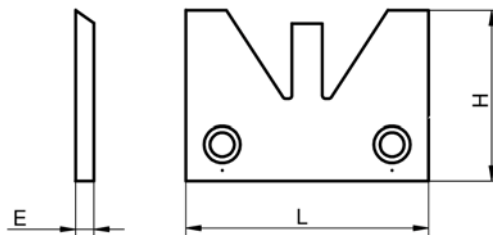
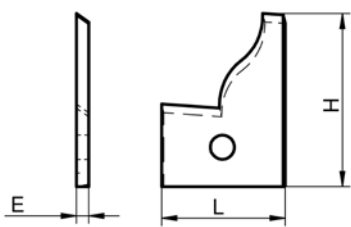

PELADORAS / ÉCORCEUSES

Cuchillas para peladoras / descortezadoras
 Plaquettes pour écorceuses

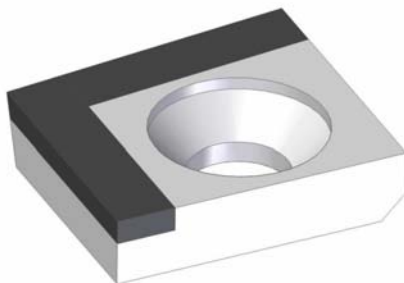

80AC

Manguitos especiales
 Manchons spéciaux

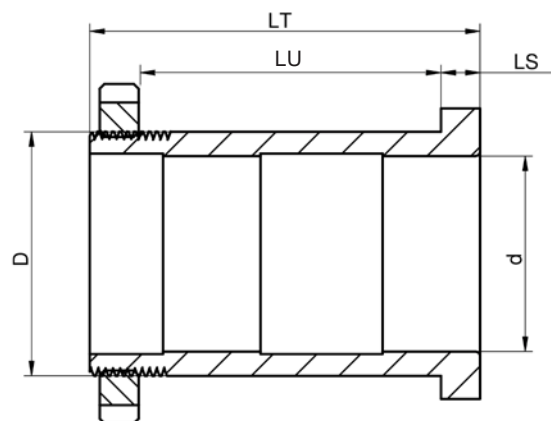

BEDANOS

Bedanos especiales HSS/MD

BÉDANES

Bédanes spéciaux HSS/HM

- S.** Espesor de corte
- P.** Profundidad de Ranura
- C.** Longitud Ranura

- S.** *Epaisseur de coupe*
- P.** *Profondeur de rainure*
- C.** *Longueur de rainure*

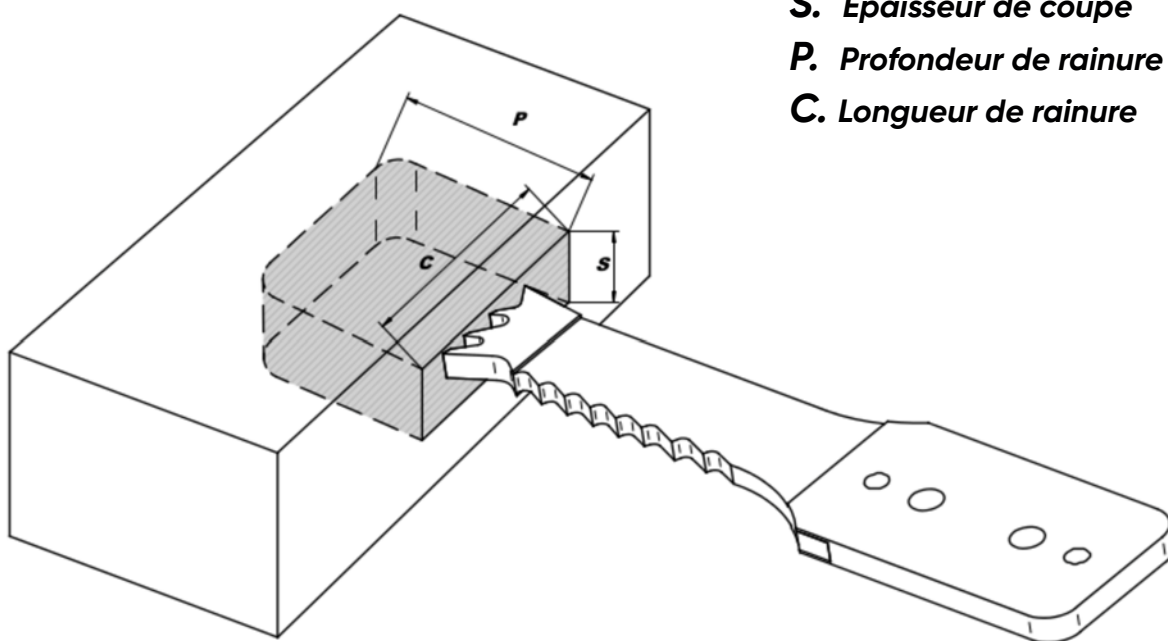

TIPO DE AMARRRES

TYPE DE SERRAGE

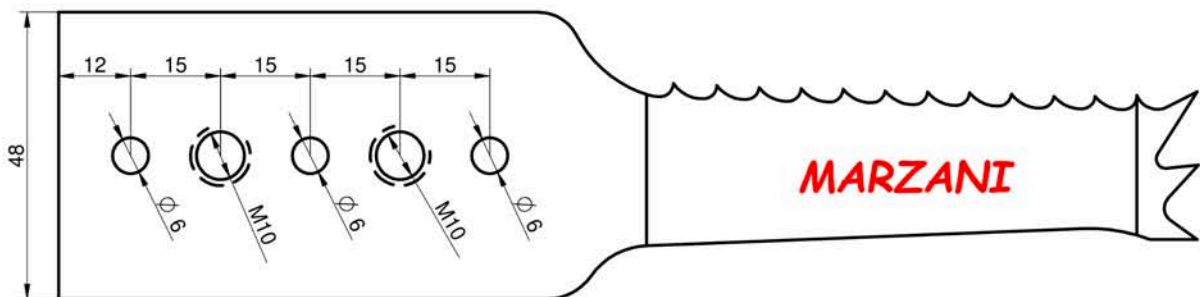
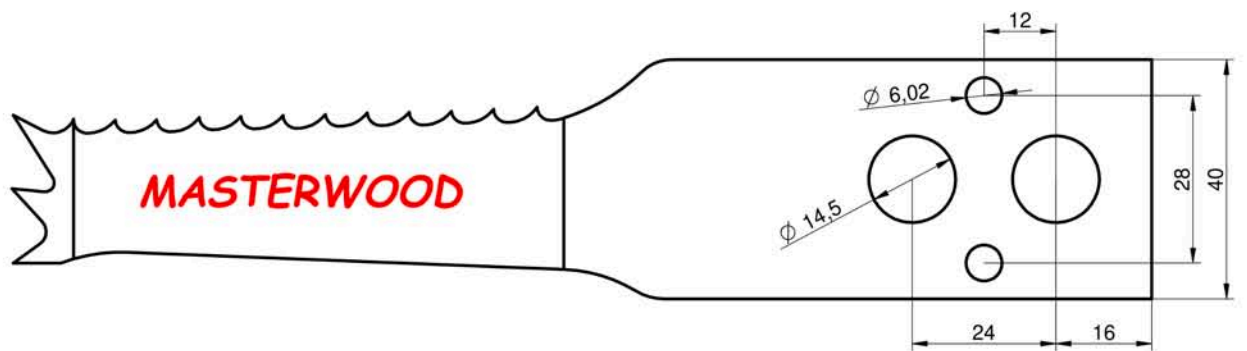
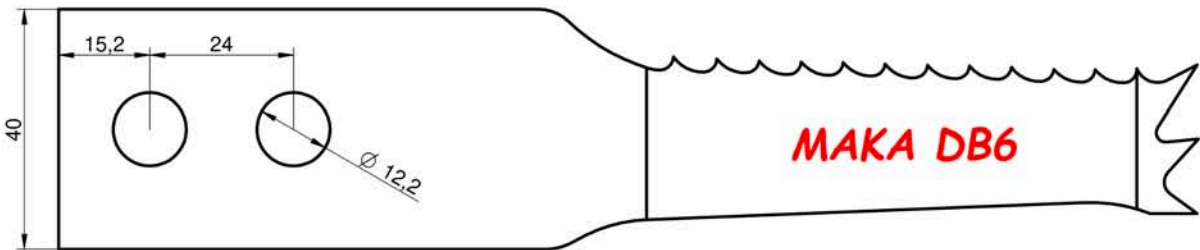
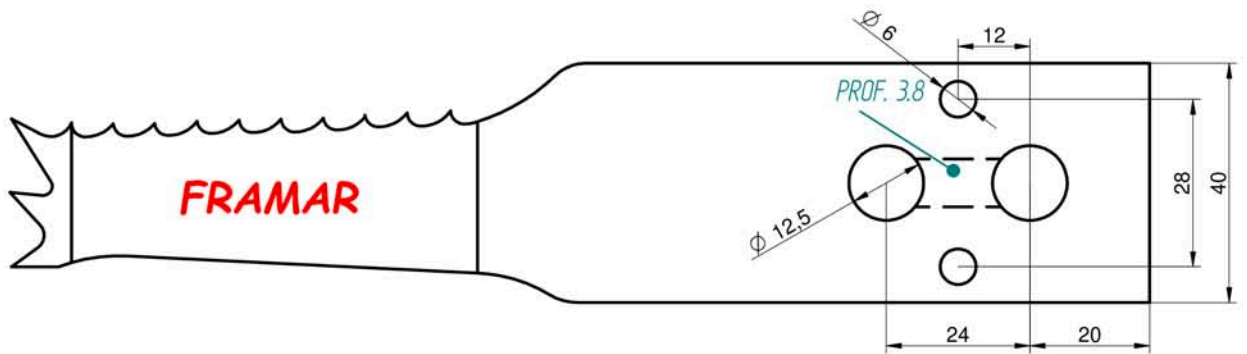
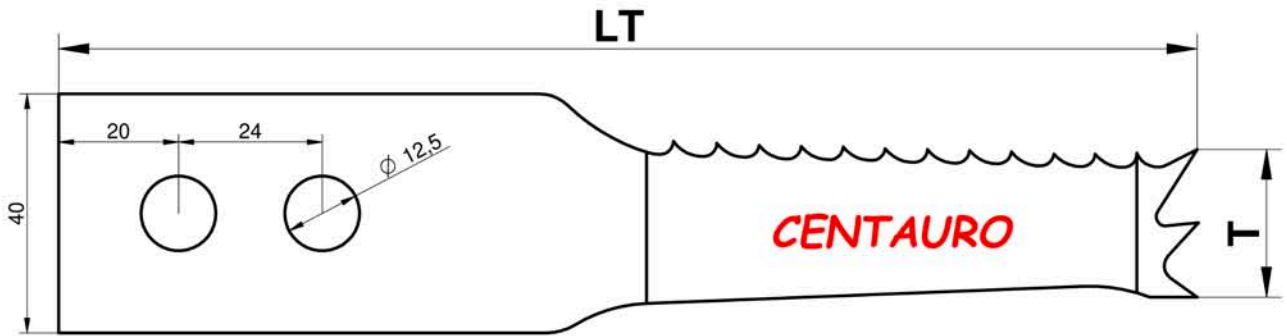

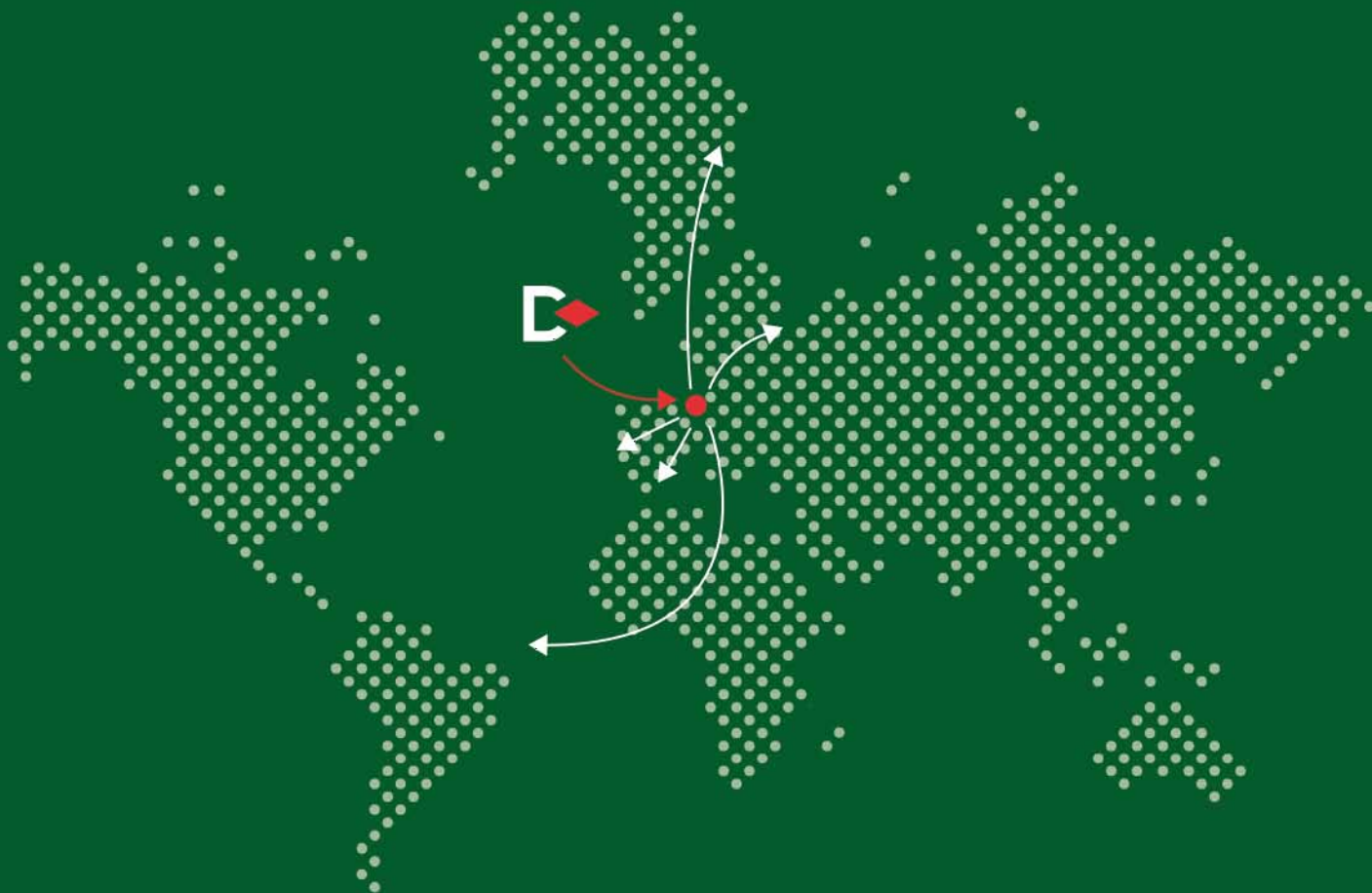

Dtools

DIATEC INTERNATIONAL TOOLS
ANARDI AREA, 3-B2
20730 AZPEITIA (GIPUZKOA)

Tel: 0034 943 81 31 45
e-mail: info@diatetectools.es

